

CERAMIC STACKED CAPACITORS FOR SWITCH MODE POWER SUPPLIES

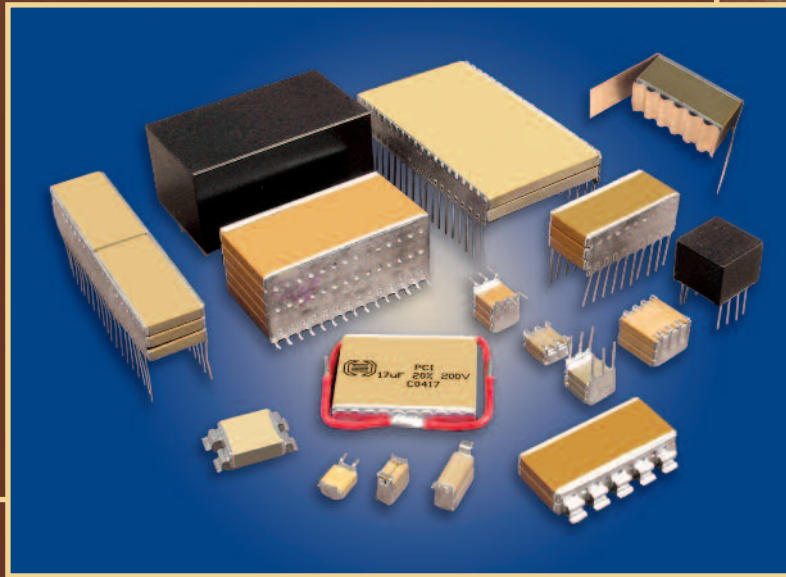

CATALOG 1001

HIGH-REL INDUSTRIAL

HIGH-REL MILITARY

HIGH-REL SPACE

HIGH VOLTAGE

TABLE OF CONTENTS

MIL-PRF-49470 INTRODUCTION.....	2
MIL-PRF-49470 STANDARD PROFILE (BX, BR, BQ).....	3-4
MIL-PRF-49470 LOW PROFILE (BX, BR, BQ).....	5
MIL-PRF-49470 STANDARD PROFILE (BP).....	6-7
MIL-PRF-49470 LOW PROFILE (BP).....	8
NOTES.....	9
MIL-PRF-49470 ELECTRICAL AND PERFORMANCE CHARACTERISTICS.....	10
AVAILABLE TEST ROUTINES & SOLDERING RECOMMENDATIONS.....	11
STACKED CAPACITORS.....	12-13
HIGH VOLTAGE STACKED CAPACITORS.....	14
HIGH FREQUENCY – HIGH POWER CAPACITORS.....	15
LOW PROFILE ‘S’ LEAD CAPACITORS AND SPECIFICATIONS.....	16-17
INTERDIGITATED STACKED CAPACITORS.....	18
PRESIDIO PRODUCT LINES.....	19

MIL-PRF-49470

**MIL-STD-790 DLA APPROVED
FACILITY AND TEST LAB
CAGE CODE: 60212**

Mil-PRF-49470 capacitors are preferred over DLA-DWG-87106 capacitors which has been cancelled. The Mil-PRF-49470 specification was developed as part of a cooperative effort between the US Military, NASA and the SMPS suppliers to produce a robust replacement for the DLA drawing. The military specification product provides additional quality assurance provisions that are NOT required by the DLA drawing. Two product levels are offered in Mil-PRF-49470: the standard “B” level (also referred to as “M” level), suitable for standard Class “H” military applications, and the high reliability “T” level, suitable for Class “K” space level applications. Some of the benefits of the Mil-PRF-49470 product over the 87106 product include: Formal qualification process (QPL established); Mil-STD-790 compliance; DLA audits; routine qualification maintenance testing (ie., life testing); Group A percent defective allowed (PDA) specified; prohibits mixing of chips from different production lots within a single SMPS stack lot.

Mil-PRF-49470 “T” Level product is recommended for all high reliability applications. Mil-PRF-49470 “T” level product requires in-process inspections and additional Group A and B screening inspections that are not part of the normal “B” level flow: In-process screening that includes non-destructive internal examination (chip level) and destructive physical analysis (chip level); Group A destructive physical analysis (finished stack level); Group B lot specific humidity, steady-state, low voltage (lot sample test); and Group B lot specific thermal shock and life test (lot sample test).

DLA DRAWING 88011 (NPO STACKED CAPACITORS)

Presidio is fully qualified to this DLA drawing.

For more information contact the factory at +1-858-578-9390 or email us at info@presidiocomponents.com.

49470 DIMENSIONS

49470 Case Code	C ± .025 in. (± .64 mm)	D inches (mm)		E (max.) inches (mm)	Number of Leads per Side
		Min.	Max.		
1	.450 (11.43)	1.950 (49.53)	2.075 (52.71)	.500 (12.70)	20
2	.800 (20.32)	1.450 (36.83)	1.535 (38.99)	.870 (22.10)	15
3	.450 (11.43)	.950 (24.13)	1.075 (27.31)	.500 (12.70)	10
4	.400 (10.16)	.350 (8.89)	.425 (10.80)	.440 (11.18)	4
5	.250 (6.35)	.224 (5.69)	.275 (6.99)	.300 (7.62)	3
6	1.250 (31.75)	1.950 (49.53)	2.075 (52.71)	1.350 (34.29)	20

49470 STANDARD PROFILE

49470 Lead Symbol (Last Digit of P/N)	Lead Style	Stack Height Profile (Dimension A)	Formed Lead Height inches (mm)
N	N (straight)	Standard	N/A
L	L (formed)	Standard	.070 ± .010 (1.78 ± 0.25)
M	L (formed)	Standard	.045 ± .010 (1.14 ± 0.25)
J	J (formed)	Standard	.070 ± .010 (1.78 ± 0.25)
K	J (formed)	Standard	.045 ± .010 (1.14 ± 0.25)

M & T LEVEL 49470/87106/88011 STANDARD PROFILE LEAD STYLE AND DIMENSIONS

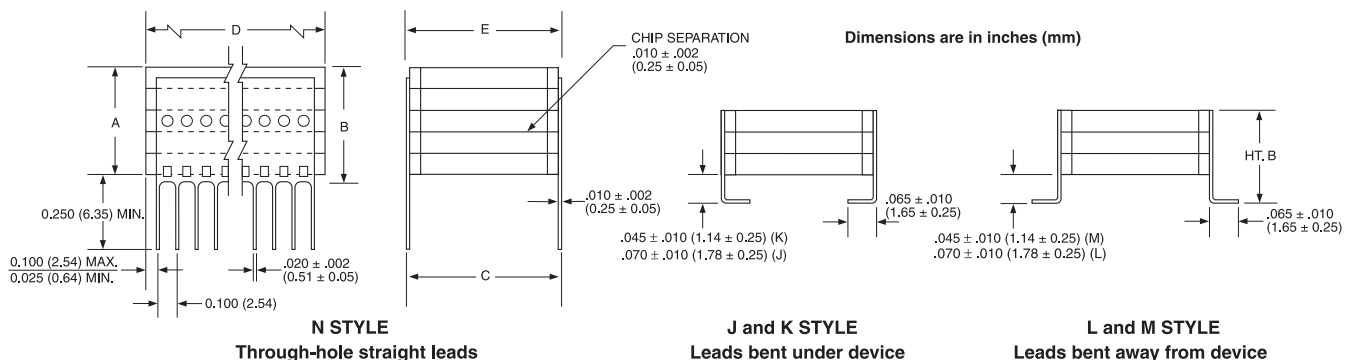

MIL-PRF-49470 STANDARD PROFILE (BX, BR, BQ)

Cross Reference from Old
Cancelled DLA Drawing 87106

MIL-PRF-49470 (Change K to M for 20% Tolerance)	Cap µF	Case Code	Height A inches (mm)	Cap Tol. 10%	Presidio Part Number (Change K to M for 20% Tolerance)	87106-xxx N-Lead		87106-xxx J-Lead		
Blue Fill = T Level Qualified		Bold = M Level Qualified			25 VOLT (Z)		K Tol.	M. Tol.	K Tol.	M Tol.

BX

**For 25V Rated QPL Stacked Capacitors
Please Contact Factory.**

Blue Fill = T Level Qualified		Bold = M Level Qualified			50 VOLT (A)	K Tol.	M. Tol.	K Tol.	M Tol.
T or M49470X01105KA*	1.0	5	.120 (3.05)	10%	HRS101BX105K2*3	001	002	241	242
T or M49470X01125KA*	1.2	5	.120 (3.05)	10%	HRS101BX125K2*3	003	004	243	244
T or M49470X01155KA*	1.5	5	.240 (6.10)	10%	HRS201BX155K2*3	005	006	245	246
T or M49470X01185KA*	1.8	5	.240 (6.10)	10%	HRS201BX185K2*3	007	008	247	248
T or M49470X01225KA*	2.2	5	.240 (6.10)	10%	HRS201BX225K2*3	009	010	249	250
T or M49470X01275KA*	2.7	5	.360 (9.14)	10%	HRS301BX275K2*3	011	012	251	252
T or M49470X01335KA*	3.3	5	.360 (9.14)	10%	HRS301BX335K2*3	013	014	253	254
T or M49470X01395KA*	3.9	5	.480 (12.19)	10%	HRS401BX395K2*3	015	016	255	256
T or M49470X01475KA*	4.7	5	.480 (12.19)	10%	HRS401BX475K2*3	017	018	257	258
T or M49470X01565KA*	5.6	5	.650 (16.51)	10%	HRS501BX565K2*3	019	020	259	260
T or M49470X01685KA*	6.8	4	.360 (9.14)	10%	HRS305BX685K2*4	223	224	261	262
T or M49470X01825KA*	8.2	4	.360 (9.14)	10%	HRS305BX825K2*4	021	022	263	264
T or M49470X01106KA*	10	4	.480 (12.19)	10%	HRS405BX106K2*4	023	024	265	266
T or M49470X01126KA*	12	4	.480 (12.19)	10%	HRS405BX126K2*4	025	026	267	268
T or M49470X01156KA*	15	4	.650 (16.51)	10%	HRS505BX156K2*4	027	028	269	270
T or M49470X01186KA*	18	3	.240 (6.10)	10%	HRS213BX186K2*10	029	030	271	272
T or M49470X01226KA*	22	3	.360 (9.14)	10%	HRS313BX226K2*10	031	032	273	274
T or M49470X01276KA*	27	3	.360 (9.14)	10%	HRS313BX276K2*10	033	034	275	276
T or M49470X01336KA*	33	3	.360 (9.14)	10%	HRS313BX336K2*10	035	036	277	278
T or M49470X01396KA*	39	3	.480 (12.19)	10%	HRS413BX396K2*10	037	038	279	280
T or M49470X01476KA*	47	3	.650 (16.51)	10%	HRS513BX476K2*10	039	040	281	282
T or M49470X01566KA*	56	1	.360 (9.14)	10%	HRS319BX566K2*20	225	226	283	284
T or M49470X01686KA*	68	1	.480 (12.19)	10%	HRS419BX686K2*20	041	042	285	286
T or M49470X01826KA*	82	1	.480 (12.19)	10%	HRS419BX826K2*20	043	044	287	288
T or M49470X01107KA*	100	1	.650 (16.51)	10%	HRS519BX107K2*20	045	046	289	290
T or M49470X01127KA*	120	2	.480 (12.19)	10%	HRS415BX127K2*15	227	228	291	292
T or M49470X01157KA*	150	2	.650 (16.51)	10%	HRS515BX157K2*15	047	048	293	294
T or M49470X01187KA*	180	6	.480 (12.19)	10%	HRS418BX187K2*20	049	050	295	296
T or M49470X01227KA*	220	6	.480 (12.19)	10%	HRS418BX227K2*20	051	052	297	298
T or M49470X01277KA*	270	6	.650 (16.51)	10%	HRS518BX277K2*20	053	054	299	300

Blue Fill = T Level Qualified		Bold = M Level Qualified			100 VOLT (B)	K Tol.	M. Tol.	K Tol.	M Tol.
T or M49470X01684KB*	.68	5	.120 (3.05)	10%	HRS101BX684K3*3	055	056	301	302
T or M49470X01824KB*	.82	5	.240 (6.10)	10%	HRS201BX824K3*3	057	058	303	304
T or M49470X01105KB*	1.0	5	.240 (6.10)	10%	HRS201BX105K3*3	059	060	305	306
T or M49470X01125KB*	1.2	5	.240 (6.10)	10%	HRS201BX125K3*3	061	062	307	308
T or M49470X01155KB*	1.5	5	.360 (9.14)	10%	HRS301BX155K3*3	063	063	309	310
T or M49470X01185KB*	1.8	5	.360 (9.14)	10%	HRS301BX185K3*3	065	066	311	312
T or M49470X01225KB*	2.2	5	.480 (12.19)	10%	HRS401BX225K3*3	067	068	313	314
T or M49470X01275KB*	2.7	5	.480 (12.19)	10%	HRS401BX275K3*3	069	070	315	316
T or M49470X01335KB*	3.3	5	.650 (16.51)	10%	HRS501BX335K3*3	071	072	317	318
T or M49470X01395KB*	3.9	4	.360 (9.14)	10%	HRS305BX395K3*4	073	074	319	320
T or M49470X01475KB*	4.7	4	.360 (9.14)	10%	HRS305BX475K3*4	075	076	321	322
T or M49470X01565KB*	5.6	4	.480 (12.19)	10%	HRS405BX565K3*4	077	078	323	324
T or M49470X01685KB*	6.8	4	.480 (12.19)	10%	HRS405BX685K3*4	079	080	325	326
T or M49470X01825KB*	8.2	4	.650 (16.51)	10%	HRS505BX825K3*4	081	082	327	328
T or M49470X01106KB*	10	3	.240 (6.10)	10%	HRS213BX106K3*10	229	230	329	330
T or M49470X01126KB*	12	3	.240 (6.10)	10%	HRS213BX126K3*10	083	084	331	332
T or M49470X01156KB*	15	3	.360 (9.14)	10%	HRS313BX156K3*10	085	086	333	334
T or M49470X01186KB*	18	3	.360 (9.14)	10%	HRS313BX186K3*10	087	088	335	336
T or M49470X01226KB*	22	3	.480 (12.19)	10%	HRS413BX226K3*10	089	090	337	338
T or M49470X01276KB*	27	3	.650 (16.51)	10%	HRS513BX276K3*10	091	092	339	340
T or M49470X01336KB*	33	1	.360 (9.14)	10%	HRS319BX336K3*20	093	094	341	342
T or M49470X01396KB*	39	1	.480 (12.19)	10%	HRS419BX396K3*20	095	096	343	344
T or M49470X01476KB*	47	1	.480 (12.19)	10%	HRS419BX476K3*20	097	098	345	346
T or M49470X01566KB*	56	1	.650 (16.51)	10%	HRS519BX566K3*20	099	100	347	348
T or M49470X01686KB*	68	2	.480 (12.19)	10%	HRS415BX686K3*15	101	102	349	350
T or M49470X01826KB*	82	2	.650 (16.51)	10%	HRS515BX826K3*15	103	104	351	352
T or M49470X01107KB*	100	6	.360 (9.14)	10%	HRS318BX107K3*20	105	106	353	354
T or M49470X01127KB*	120	6	.360 (9.14)	10%	HRS318BX127K3*20	107	108	355	356
T or M49470X01157KB*	150	6	.480 (12.19)	10%	HRS418BX157K3*20	109	110	357	358
T or M49470X01187KB*	180	6	.650 (16.51)	10%	HRS518BX187K3*20	111	112	359	360



PRESIDIO COMPONENTS, INC.

7169 Construction Court, San Diego, CA 92121 USA • Tel: +1-858-578-9390 • Fax: +1-858-578-6225

www.presidiocomponents.com • info@presidiocomponents.com

MIL-PRF-49470 STANDARD PROFILE (BX, BR, BQ)

Cross Reference from Old
Cancelled DLA Drawing 87106

MIL-PRF-49470 (Change K to M for 20% Tolerance)	Cap μF	Case Code	Height A inches (mm)	Cap Tol. 10%	Presidio Part Number (Change K to M for 20% Tolerance)	87106-xxx N-Lead		87106-xxx J-Lead		
Blue Fill = T Level Qualified			Bold = M Level Qualified		200 VOLT (C)	K Tol.	M Tol.	K Tol.	M Tol.	
BR	T or M49470R01474KC*	.47	5	.240 (6.10)	10%	HRS201BR474K4*3	113	114	361	362
	T or M49470R01564KC*	.56	5	.240 (6.10)	10%	HRS201BR564K4*3	115	116	363	364
	T or M49470R01684KC*	.68	5	.360 (9.14)	10%	HRS301BR684K4*3	117	118	365	366
	T or M49470R01824KC*	.82	5	.360 (9.14)	10%	HRS301BR824K4*3	119	120	367	368
	T or M49470R01105KC*	1.0	5	.480 (12.19)	10%	HRS401BR105K4*3	121	122	369	370
	T or M49470R01125KC*	1.2	5	.480 (12.19)	10%	HRS401BR125K4*3	123	124	371	372
	T or M49470R01155KC*	1.5	5	.650 (16.51)	10%	HRS501BR155K4*3	125	126	373	374
	T or M49470R01185KC*	1.8	4	.360 (9.14)	10%	HRS305BR185K4*4	127	128	375	376
	T or M49470R01225KC*	2.2	4	.360 (9.14)	10%	HRS305BR225K4*4	129	130	377	378
	T or M49470R01275KC*	2.7	4	.480 (12.19)	10%	HRS405BR275K4*4	131	132	379	380
	T or M49470R01335KC*	3.3	4	.480 (12.19)	10%	HRS405BR335K4*4	133	134	381	382
	T or M49470R01395KC*	3.9	4	.650 (16.51)	10%	HRS505BR395K4*4	135	136	383	384
	T or M49470R01475KC*	4.7	3	.240 (6.10)	10%	HRS213BR475K4*10	137	138	385	386
	T or M49470R01565KC*	5.6	3	.240 (6.10)	10%	HRS213BR565K4*10	139	140	387	388
	T or M49470R01685KC*	6.8	3	.360 (9.14)	10%	HRS313BR1685K4*10	141	142	389	390
	T or M49470R01825KC*	8.2	3	.360 (9.14)	10%	HRS313BR825K4*10	143	144	391	392
	T or M49470R01106KC*	10	3	.480 (12.19)	10%	HRS413BR106K4*10	145	146	393	394
	T or M49470R01126KC*	12	3	.650 (16.51)	10%	HRS513BR126K4*10	147	148	395	396
	T or M49470R01156KC*	15	1	.360 (9.14)	10%	HRS319BR156K4*20	149	150	397	398
	T or M49470R01186KC*	18	1	.480 (12.19)	10%	HRS419BR186K4*20	151	152	399	400
	T or M49470R01226KC*	22	1	.650 (16.51)	10%	HRS519BR226K4*20	153	154	401	402
	T or M49470R01276KC*	27	1	.650 (16.51)	10%	HRS519BR276K4*20	155	156	403	404
	T or M49470R01336KC*	33	2	.480 (12.19)	10%	HRS415BR336K4*15	157	158	405	406
	T or M49470R01396KC*	39	2	.650 (16.51)	10%	HRS415BR396K4*15	159	160	407	408
	T or M49470R01476KC*	47	6	.240 (6.10)	10%	HRS218BR476K4*20	161	162	409	410
	T or M49470R01566KC*	56	6	.360 (9.14)	10%	HRS318BR566K4*20	163	164	411	412
	T or M49470R01686KC*	68	6	.360 (9.14)	10%	HRS318BR686K4*20	165	166	413	414
	T or M49470R01826KC*	82	6	.480 (12.19)	10%	HRS418BR826K4*20	167	168	415	416
	T or M49470R01107KC*	100	6	.650 (16.51)	10%	HRS518BR107K4*20	169	170	417	418
	T or M49470R01127KC*	120	6	.650 (16.51)	10%	HRS518BR127K4*20	171	172	419	420
Blue Fill = T Level Qualified			Bold = M Level Qualified		500 VOLT (E)	K Tol.	M. Tol.	K Tol.	M Tol.	
BQ	T or M49470Q01154KE*	.15	5	.120 (3.05)	10%	HRS101BQ154K6*3	173	174	421	422
	T or M49470Q01184KE*	.18	5	.240 (6.10)	10%	HRS201BQ184K6*3	175	176	423	424
	T or M49470Q01224KE*	.22	5	.240 (6.10)	10%	HRS201BQ224K6*3	177	178	425	426
	T or M49470Q01274KE*	.27	5	.240 (6.10)	10%	HRS201BQ274K6*3	179	180	427	428
	T or M49470Q01334KE*	.33	5	.360 (9.14)	10%	HRS301BQ334K6*3	181	182	429	430
	T or M49470Q01394KE*	.39	5	.360 (9.14)	10%	HRS301BQ394K6*3	183	184	431	432
	T or M49470Q01474KE*	.47	5	.360 (9.14)	10%	HRS301BQ474K6*3	185	186	433	434
	T or M49470Q01564KE*	.56	5	.480 (12.19)	10%	HRS401BQ564K6*3	187	188	435	436
	T or M49470Q01684KE*	.68	5	.650 (16.51)	10%	HRS501BQ684K6*3	189	190	437	438
	T or M49470Q01824KE*	.82	4	.360 (9.14)	10%	HRS305BQ824K6*4	231	232	439	440
	T or M49470Q01105KE*	1.0	4	.360 (9.14)	10%	HRS305BQ105K6*4	191	192	441	442
	T or M49470Q01125KE*	1.2	4	.360 (9.14)	10%	HRS305BQ125K6*4	193	194	443	444
	T or M49470Q01155KE*	1.5	4	.480 (12.19)	10%	HRS405BQ155K6*4	195	196	445	446
	T or M49470Q01185KE*	1.8	4	.650 (16.51)	10%	HRS505BQ185K6*4	197	198	447	448
	T or M49470Q01225KE*	2.2	3	.240 (6.10)	10%	HRS213BQ225K6*10	233	234	449	450
	T or M49470Q01275KE*	2.7	3	.360 (9.14)	10%	HRS313BQ275K6*10	199	200	451	452
	T or M49470Q01335KE*	3.3	3	.360 (9.14)	10%	HRS313BQ335K6*10	201	202	453	454
	T or M49470Q01395KE*	3.9	3	.360 (9.14)	10%	HRS313BQ395K6*10	203	204	455	456
	T or M49470Q01475KE*	4.7	3	.480 (12.19)	10%	HRS413BQ475K6*10	205	206	457	458
	T or M49470Q01565KE*	5.6	3	.650 (16.51)	10%	HRS513BQ565K6*10	207	208	459	460
	T or M49470Q01685KE*	6.8	1	.480 (12.19)	10%	HRS419BQ685K6*20	235	236	461	462
	T or M49470Q01825KE*	8.2	1	.480 (12.19)	10%	HRS419BQ825K6*20	209	210	463	464
	T or M49470Q01106KE*	10	1	.480 (12.19)	10%	HRS419BQ106K6*20	211	212	465	466
	T or M49470Q01126KE*	12	1	.650 (16.51)	10%	HRS519BQ126K6*20	213	214	467	468
	T or M49470Q01156KE*	15	2	.650 (16.51)	10%	HRS515BQ156K6*15	237	238	469	470
	T or M49470Q01186KE*	18	2	.650 (16.51)	10%	HRS415BQ186K6*15	215	216	471	472
	T or M49470Q01226KE*	22	6	.360 (9.14)	10%	HRS318BQ226K6*20	239	240	473	474
	T or M49470Q01276KE*	27	6	.360 (9.14)	10%	HRS318BQ276K6*20	217	218	475	476
	T or M49470Q01336KE*	33	6	.480 (12.19)	10%	HRS418BQ336K6*20	219	220	477	478
	T or M49470Q01396KE*	39	6	.650 (16.51)	10%	HRS418BQ396K6*20	221	222	479	480

Note 1: Asterisk (*) refers to lead style N through K; consult factory or DLA website for qualification status.

Note 2: Parts can also be ordered with 20% cap tolerance; include "M" in the Presidio part number. Example: HRS313BQ335M6*10

MIL-PRF-49470 QPL STANDARD PROFILE PART NUMBER

T49470

Product Level
for Level B, use M
for Level T, use T

Q

Dielectric
Characteristic
(X, R, Q)
See page 10

01

Performance
Specification
Slash Sheet Number
Indicating
MIL-PRF-49470/1&2

186

Capacitance
Value (in picofarads):
Two significant figures
followed by the number of
zeros. Examples:
103 = 10,000 pF = .01 μF
186 = 18,000,000 pF = 18 μF

K

Capacitance
Tolerance
K = 10%
M = 20%

E

Rated Voltage
(Z, A, B, C, E)

N

Lead
Configuration
(N, L, M, J, K)



MIL-PRF-49470 LOW PROFILE (BX, BR, BQ) REDUCED HEIGHT – LARGER CASE SIZE

MIL-PRF-49470 (Change K to M for 20% Tol.)	Cap µF	Case Code	Height A inches (mm)	Cap Tol. 10%	Presidio Part No. (Change K to M for 20% Tol.)	
Blue Fill = T Level		Bold = M Level		25 VOLT (Z)		
BX For 25V Rated QPL Stacked Capacitors Please Contact Factory.						
Blue Fill = T Level		Bold = M Level		50 VOLT (A)		
BX	T or M49470X01475KA*	4.7	4	.240 (6.10)	10%	HRS205BX475K2*4
	T or M49470X01565KA*	5.6	4	.240 (6.10)	10%	HRS205BX565K2*4
	T or M49470X01156KA*	15	3	.240 (6.10)	10%	HRS213BX156K2*10
	T or M49470X01476KA*	47	2	.240 (6.10)	10%	HRS215BX476K2*15
	T or M49470X01566KA*	56	2	.240 (6.10)	10%	HRS215BX566K2*15
	T or M49470X01686KA*	68	2	.360 (9.14)	10%	HRS315BX686K2*15
	T or M49470X01826KA*	82	2	.360 (9.14)	10%	HRS315BX826K2*15
T or M49470X01107KA*	100	2	.480 (12.19)	10%	HRS415BX107K2*15	
Blue Fill = T Level		Bold = M Level		100 VOLT (B)		
BX	T or M49470X01225KB*	2.2	4	.240 (6.10)	10%	HRS205BX225K3*4
	T or M49470X01335KB*	3.3	4	.240 (6.10)	10%	HRS205BX335K3*4
	T or M49470X01825KB*	8.2	3	.240 (6.10)	10%	HRS213BX825K3*10
	T or M49470X01276KB*	27	2	.240 (6.10)	10%	HRS215BX276K3*15
	T or M49470X01336KB*	33	2	.240 (6.10)	10%	HRS215BX336K3*15
	T or M49470X01396KB*	39	2	.360 (9.14)	10%	HRS315BX396K3*15
	T or M49470X01476KB*	47	2	.360 (9.14)	10%	HRS315BX476K3*15
Blue Fill = T Level		Bold = M Level		200 VOLT (C)		
BR	T or M49470R01105KC*	1.0	4	.120 (3.05)	10%	HRS105BR105K4*4
	T or M49470R01125KC*	1.2	4	.240 (6.10)	10%	HRS205BR125K4*4
	T or M49470R01155KC*	1.5	4	.240 (6.10)	10%	HRS205BR155K4*4
	T or M49470R01395KC*	3.9	3	.240 (6.10)	10%	HRS213BR395K4*10
	T or M49470R01126KC*	12	2	.240 (6.10)	10%	HRS215BR126K4*15
	T or M49470R01156KC*	15	2	.240 (6.10)	10%	HRS215BR156K4*15
	T or M49470R01186KC*	18	2	.360 (9.14)	10%	HRS315BR186K4*15
	T or M49470R01226KC*	22	2	.360 (9.14)	10%	HRS315BR226K4*15
	T or M49470R01276KC*	27	2	.480 (12.19)	10%	HRS415BR276K4*15
Blue Fill = T Level		Bold = M Level		500 VOLT (E)		
BQ	T or M49470Q01564KE*	.56	4	.240 (6.10)	10%	HRS205BQ564K6*4
	T or M49470Q01684KE*	.68	4	.240 (6.10)	10%	HRS205BQ684K6*4
	T or M49470Q01185KE*	1.8	3	.240 (6.10)	10%	HRS213BQ185K6*10
	T or M49470Q01565KE*	5.6	2	.240 (6.10)	10%	HRS215BQ565K6*15
	T or M49470Q01685KE*	6.8	2	.240 (6.10)	10%	HRS215BQ685K6*15
	T or M49470Q01825KE*	8.2	2	.360 (9.14)	10%	HRS315BQ825K6*15
	T or M49470Q01106KE*	10	2	.360 (9.14)	10%	HRS315BQ106K6*15
	T or M49470Q01126KE*	12	2	.480 (12.19)	10%	HRS415BQ126K6*15

PRESIDIO'S MIL-PRF-49470 LOW PROFILE CAPACITORS

Asterisk in Part Number (*) refers to lead style A — F. Consult factory or DLA website for qualification status.

For these parts "low profile" indicates the height has been reduced by using a larger case code and reducing the number of chips per stack.

Presidio is a world leader in the manufacturing of ceramic stacked capacitors. We can optimize our design for the foot print and height available on your board. We are easy to reach.

Please contact our engineering team at
+1-858-578-9390
or email us at info@presidiocomponents.com.

49470 LOW PROFILE LEADS

49470 Lead Symbol (Last Digit of P/N)	Lead Style	Stack Height Profile (Dimension A)	Formed Lead Height inches (mm)
A	N (straight)	Low	N/A
B	L (formed)	Low	.070 ± .010 (1.78 ± 0.25)
D	L (formed)	Low	.045 ± .010 (1.14 ± 0.25)
C	J (formed)	Low	.070 ± .010 (1.78 ± 0.25)
F	J (formed)	Low	.045 ± .010 (1.14 ± 0.25)

49470 LOW PROFILE DIMENSIONS

49470 Case Code	C ± .025 in. (± .64 mm)	D inches (mm)		E (max.) inches (mm)	Number of Leads per Side
		Min.	Max.		
1	.450 (11.43)	1.950 (49.53)	2.075 (52.71)	.500 (12.70)	20
2	.800 (20.32)	1.450 (36.83)	1.535 (38.99)	.870 (22.10)	15
3	.450 (11.43)	.950 (24.13)	1.075 (27.31)	.500 (12.70)	10
4	.400 (10.16)	.350 (8.89)	.425 (10.80)	.440 (11.18)	4
5	.250 (6.35)	.224 (5.69)	.275 (6.99)	.300 (7.62)	3
6	1.250 (31.75)	1.950 (49.53)	2.075 (52.71)	1.350 (34.29)	20

M & T LEVEL 49470 LOW PROFILE LEAD STYLE AND DIMENSIONS

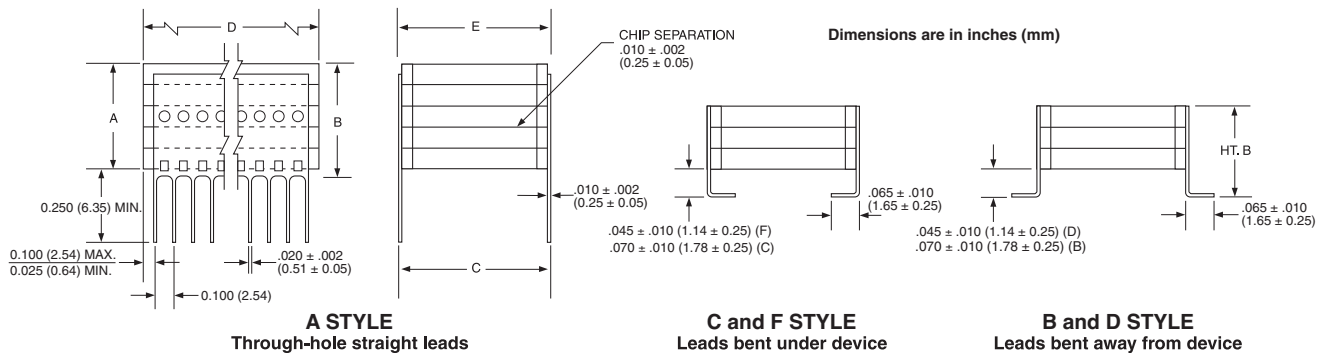

MIL-PRF-49470 QPL LOW PROFILE PART NUMBER

T49470	Q	01	126	K	A	D
Product Level for Level B, use M for Level T, use T	Dielectric Characteristic (X, R, Q) See page 10	Performance Specification Slash Sheet Number Indicating MIL-PRF-49470/1&2	Capacitance Value (in picofarads): Two significant figures followed by the number of zeros. Examples: 103 = 10,000 pF = .01 µF 126 = 12,000,000 pF = 12 µF	Capacitance Tolerance K = 10% M = 20%	Rated Voltage (Z, A, B, C, E)	Lead Configuration (A, B, D, C, F)

MIL-PRF-49470 STANDARD PROFILE (BP)

Cross Reference from
DLA Drawing 88011

MIL-PRF-49470 (Change J to K for 10% Tolerance)	Cap µF	Case Code	Height A inches (mm)	Cap Tol. 5%	Presidio Part Number (Change J to K for 10% Tolerance)	88011-xxx	
Blue Fill = T Level Qualified	Bold = M Level Qualified			50 VOLT (A)		J Tol.	K Tol.
T or M49470P01563JA*	0.056	5	.120 (3.05)	5%	HRS101BP563J2*3	001 -	002 -
T or M49470P01683JA*	0.068	5	.240 (6.10)	5%	HRS201BP683J2*3	003 -	004 -
T or M49470P01823JA*	0.082	5	.240 (6.10)	5%	HRS201BP823J2*3	005 -	006 -
T or M49470P01104JA*	0.1	5	.240 (6.10)	5%	HRS201BP104J2*3	007 -	008 -
T or M49470P0124JA*	0.12	5	.360 (9.14)	5%	HRS301BP124J2*3	009 -	010 -
T or M49470P01154JA*	0.15	5	.360 (9.14)	5%	HRS301BP154J2*3	011 -	012 -
T or M49470P01184JA*	0.18	5	.480 (12.19)	5%	HRS401BP184J2*3	013 -	014 -
T or M49470P01224JA*	0.22	5	.480 (12.19)	5%	HRS401BP224J2*3	015 -	016 -
T or M49470P01274JA*	0.27	5	.650 (16.51)	5%	HRS501BP274J2*3	017 -	018 -
T or M49470P01334JA*	0.33	4	.360 (9.14)	5%	HRS305BP334J2*4	019 -	020 -
T or M49470P01394JA*	0.39	4	.480 (12.19)	5%	HRS405BP394J2*4	021 -	022 -
T or M49470P01474JA*	0.47	4	.480 (12.19)	5%	HRS405BP474J2*4	023 -	024 -
T or M49470P01564JA*	0.56	4	.650 (16.51)	5%	HRS505BP564J2*4	025 -	026 -
T or M49470P01684JA*	0.68	3	.240 (6.10)	5%	HRS213BP684J2*10	027 -	028 -
T or M49470P01824JA*	0.82	3	.240 (6.10)	5%	HRS213BP824J2*10	029 -	030 -
T or M49470P01105JA*	1	3	.360 (9.14)	5%	HRS313BP105J2*10	031 -	032 -
T or M49470P01125JA*	1.2	3	.360 (9.14)	5%	HRS313BP125J2*10	033 -	034 -
T or M49470P01155JA*	1.5	3	.480 (12.19)	5%	HRS413BP155J2*10	035 -	036 -
T or M49470P01185JA*	1.8	3	.480 (12.19)	5%	HRS413BP185J2*10	037 -	038 -
T or M49470P01225JA*	2.2	3	.650 (16.51)	5%	HRS513BP225J2*10	039 -	040 -
T or M49470P01275JA*	2.7	1	.360 (9.14)	5%	HRS319BP275J2*20	041 -	042 -
T or M49470P01335JA*	3.3	1	.480 (12.19)	5%	HRS419BP335J2*20	043 -	044 -
T or M49470P01395JA*	3.9	1	.480 (12.19)	5%	HRS419BP395J2*20	045 -	046 -
T or M49470P01475JA*	4.7	1	.650 (16.51)	5%	HRS519BP475J2*20	047 -	048 -
T or M49470P01565JA*	5.6	2	.650 (16.51)	5%	HRS515BP565J2*15	049 -	050 -
T or M49470P01685JA*	6.8	6	.360 (9.14)	5%	HRS318BP685J2*20	051 -	052 -
T or M49470P01825JA*	8.2	6	.360 (9.14)	5%	HRS318BP825J2*20	053 -	054 -
T or M49470P01106JA*	10	6	.480 (12.19)	5%	HRS418BP106J2*20	055 -	056 -
T or M49470P01126JA*	12	6	.480 (12.19)	5%	HRS418BP126J2*20	057 -	058 -
T or M49470P01156JA*	15	6	.650 (16.51)	5%	HRS518BP156J2*20	059 -	060 -
Blue Fill = T Level Qualified	Bold = M Level Qualified			100 VOLT (B)		J Tol.	K Tol.
T or M49470P01473JB*	0.047	5	.240 (6.10)	5%	HRS201BP473J3*3	061 -	062 -
T or M49470P01563JB*	0.056	5	.240 (6.10)	5%	HRS201BP563J3*3	063 -	064 -
T or M49470P01683JB*	0.068	5	.240 (6.10)	5%	HRS201BP683J3*3	065 -	066 -
T or M49470P01823JB*	0.082	5	.240 (6.10)	5%	HRS201BP823J3*3	067 -	068 -
T or M49470P01104JB*	0.1	5	.360 (9.14)	5%	HRS301BP104J3*3	069 -	070 -
T or M49470P01124JB*	0.12	5	.360 (9.14)	5%	HRS301BP124J3*3	071 -	072 -
T or M49470P01154JB*	0.15	5	.480 (12.19)	5%	HRS401BP154J3*3	073 -	074 -
T or M49470P01184JB*	0.18	5	.480 (12.19)	5%	HRS401BP184J3*3	075 -	076 -
T or M49470P01224JB*	0.22	5	.650 (16.51)	5%	HRS501BP224J3*3	077 -	078 -
T or M49470P01274JB*	0.27	4	.360 (9.14)	5%	HRS305BP274J3*4	076 -	080 -
T or M49470P01334JB*	0.33	4	.480 (12.19)	5%	HRS405BP334J3*4	081 -	082 -
T or M49470P01394JB*	0.39	4	.480 (12.19)	5%	HRS405BP394J3*4	083 -	084 -
T or M49470P01474JB*	0.47	4	.650 (16.51)	5%	HRS505BP474J3*4	085 -	086 -
T or M49470P01564JB*	0.56	4	.650 (16.51)	5%	HRS505BP564J3*4	087 -	088 -
T or M49470P01684JB*	0.68	3	.240 (6.10)	5%	HRS213BP684J3*10	089 -	090 -
T or M49470P01824JB*	0.82	3	.360 (9.14)	5%	HRS313BP824J3*10	091 -	092 -
T or M49470P01105JB*	1	3	.360 (9.14)	5%	HRS313BP105J3*10	093 -	094 -
T or M49470P01125JB*	1.2	3	.480 (12.19)	5%	HRS413BP125J3*10	095 -	096 -
T or M49470P01155JB*	1.5	3	.480 (12.19)	5%	HRS413BP155J3*10	097 -	098 -
T or M49470P01185JB*	1.8	3	.650 (16.51)	5%	HRS513BP185J3*10	099 -	100 -
T or M49470P01225JB*	2.2	1	.480 (12.19)	5%	HRS419BP225J3*20	101 -	102 -
T or M49470P01275JB*	2.7	1	.480 (12.19)	5%	HRS419BP275J3*20	103 -	104 -
T or M49470P01335JB*	3.3	1	.650 (16.51)	5%	HRS519BP335J3*20	105 -	106 -
T or M49470P01395JB*	3.9	2	.480 (12.19)	5%	HRS415BP395J3*15	107 -	108 -
T or M49470P01475JB*	4.7	2	.650 (16.51)	5%	HRS515BP475J3*15	109 -	110 -
T or M49470P01565JB*	5.6	6	.360 (9.14)	5%	HRS318BP565J3*20	111 -	112 -
T or M49470P01685JB*	6.8	6	.360 (9.14)	5%	HRS318BP685J3*20	113 -	114 -
T or M49470P01825JB*	8.2	6	.480 (12.19)	5%	HRS418BP825J3*20	115 -	116 -
T or M49470P01106JB*	10	6	.650 (16.51)	5%	HRS518BP106J3*20	117 -	118 -
T or M49470P01126JB*	12	6	.650 (16.51)	5%	HRS518BP126J3*20	119 -	120 -

Note 1: Asterisk (*) refers to lead style N through K; consult factory or DLA website for qualification status.

Note 2: Parts can also be ordered with 10% or 20% cap tolerance; include "K" or "M" in the Presidio part number. Example: HRS313BP105K2*10

MIL-PRF-49470 QPL STANDARD PROFILE PART NUMBER

T49470

P

01

474

J

B

J

Product Level
for Level B, use M
for Level T, use T

Dielectric
Characteristic
(BP)
See page 10

Performance
Specification
Slash Sheet Number
Indicating
MIL-PRF-49470/1&2

Capacitance
Value (in picofarads):
Two significant figures
followed by the number of
zeros. Examples:
103 = 10,000 pF = .01 µF
474 = 474,000 pF = 0.47 µF

Capacitance
Tolerance
J = 5% (BP Only)
K = 10%
M = 20%

Rated Voltage
(Z, A, B, C, E)

Lead
Configuration
(N, L, M, J, K)



MIL-PRF-49470 STANDARD PROFILE (BP)

Cross Reference from
DLA Drawing 88011

MIL-PRF-49470 (Change J to K for 10% Tolerance)	Cap µF	Case Code	Height A inches (mm)	Cap Tol. 5%	Presidio Part Number (Change J to K for 10% Tolerance)	88011-xxx	
Blue Fill = T Level Qualified		Bold = M Level Qualified			200 VOLT (C)	J Tol.	K Tol.
T or M49470P01223JC*	0.022	5	.120 (3.05)	5%	HRS101BP223J4*3	121 -	122 -
T or M49470P01273JC*	0.027	5	.240 (6.10)	5%	HRS201BP273J4*3	123 -	124 -
T or M49470P01333JC*	0.033	5	.240 (6.10)	5%	HRS201BP333J4*3	125 -	126 -
T or M49470P01393JC*	0.039	5	.240 (6.10)	5%	HRS201BP393J4*3	127 -	128 -
T or M49470P01473JC*	0.047	5	.360 (9.14)	5%	HRS301BP473J4*3	129 -	130 -
T or M49470P01563JC*	0.056	5	.360 (9.14)	5%	HRS301BP563J4*3	131 -	132 -
T or M49470P01683JC*	0.068	5	.480 (12.19)	5%	HRS401BP683J4*3	133 -	134 -
T or M49470P01823JC*	0.082	5	.480 (12.19)	5%	HRS401BP823J4*3	135 -	136 -
T or M49470P01104JC*	0.1	5	.650 (16.51)	5%	HRS501BP104J4*3	137 -	138 -
T or M49470P01124JC*	0.12	4	.360 (9.14)	5%	HRS305BP124J4*4	139 -	140 -
T or M49470P01154JC*	0.15	4	.360 (9.14)	5%	HRS305BP154J4*4	141 -	142 -
T or M49470P01184JC*	0.18	4	.480 (12.19)	5%	HRS405BP184J4*4	143 -	144 -
T or M49470P01224JC*	0.22	4	.480 (12.19)	5%	HRS405BP224J4*4	145 -	146 -
T or M49470P01274JC*	0.27	4	.650 (16.51)	5%	HRS505BP274J4*4	147 -	148 -
T or M49470P01334JC*	0.33	3	.240 (6.10)	5%	HRS213BP334J4*10	149 -	150 -
T or M49470P01394JC*	0.39	3	.240 (6.10)	5%	HRS213BP394J4*10	151 -	152 -
T or M49470P01474JC*	0.47	3	.360 (9.14)	5%	HRS313BP474J4*10	153 -	154 -
T or M49470P01564JC*	0.56	3	.360 (9.14)	5%	HRS313BP564J4*10	155 -	156 -
T or M49470P01684JC*	0.68	3	.480 (12.19)	5%	HRS413BP684J4*10	157 -	158 -
T or M49470P01824JC*	0.82	3	.650 (16.51)	5%	HRS513BP824J4*10	159 -	160 -
T or M49470P01105JC*	1	3	.650 (16.51)	5%	HRS513BP105J4*10	161 -	162 -
T or M49470P01125JC*	1.2	1	.480 (12.19)	5%	HRS419BP125J4*20	163 -	164 -
T or M49470P01155JC*	1.5	1	.480 (12.19)	5%	HRS419BP155J4*20	165 -	166 -
T or M49470P01185JC*	1.8	1	.650 (16.51)	5%	HRS519BP185J4*20	167 -	168 -
T or M49470P01225JC*	2.2	2	.480 (12.19)	5%	HRS415BP225J4*15	169 -	170 -
T or M49470P01275JC*	2.7	2	.650 (16.51)	5%	HRS515BP275J4*15	171 -	172 -
T or M49470P01335JC*	3.3	6	.360 (9.14)	5%	HRS318BP335J4*20	173 -	174 -
T or M49470P01395JC*	3.9	6	.360 (9.14)	5%	HRS318BP395J4*20	175 -	176 -
T or M49470P01475JC*	4.7	6	.480 (12.19)	5%	HRS418BP475J4*20	177 -	178 -
T or M49470P01565JC*	5.6	6	.650 (16.51)	5%	HRS518BP565J4*20	179 -	180 -
Blue Fill = T Level Qualified		Bold = M Level Qualified			500 VOLT (B)	J Tol.	K Tol.
T or M49470P01103JE*	0.01	5	.120 (3.05)	5%	HRS101BP103J6*3	181 -	182 -
T or M49470P01123JE*	0.012	5	.240 (6.10)	5%	HRS201BP123J6*3	183 -	184 -
T or M49470P01153JE*	0.015	5	.240 (6.10)	5%	HRS201BP153J6*3	185 -	186 -
T or M49470P01183JE*	0.018	5	.240 (6.10)	5%	HRS201BP183J6*3	187 -	188 -
T or M49470P01223JE*	0.022	5	.360 (9.14)	5%	HRS301BP223J6*3	189 -	190 -
T or M49470P01273JE*	0.027	5	.360 (9.14)	5%	HRS301BP273J6*3	191 -	192 -
T or M49470P01333JE*	0.033	5	.480 (12.19)	5%	HRS401BP333J6*3	193 -	194 -
T or M49470P01393JE*	0.039	5	.480 (12.19)	5%	HRS401BP393J6*3	195 -	196 -
T or M49470P01473JE*	0.047	5	.650 (16.51)	5%	HRS501BP473J6*3	197 -	198 -
T or M49470P01563JE*	0.056	4	.360 (9.14)	5%	HRS305BP563J6*4	199 -	200 -
T or M49470P01683JE*	0.068	4	.360 (9.14)	5%	HRS305BP683J6*4	201 -	202 -
T or M49470P01823JE*	0.082	4	.480 (12.19)	5%	HRS405BP823J6*4	203 -	204 -
T or M49470P01104JE*	0.1	4	.480 (12.19)	5%	HRS405BP104J6*4	205 -	206 -
T or M49470P01124JE*	0.12	4	.650 (16.51)	5%	HRS505BP124J6*4	207 -	208 -
T or M49470P01154JE*	0.15	3	.240 (6.10)	5%	HRS213BP154J6*10	209 -	210 -
T or M49470P01184JE*	0.18	3	.240 (6.10)	5%	HRS213BP184J6*10	211 -	212 -
T or M49470P01224JE*	0.22	3	.360 (9.14)	5%	HRS313BP224J6*10	213 -	214 -
T or M49470P01274JE*	0.27	3	.360 (9.14)	5%	HRS313BP274J6*10	215 -	216 -
T or M49470P01334JE*	0.33	3	.480 (12.19)	5%	HRS413BP334J6*10	217 -	218 -
T or M49470P01394JE*	0.39	3	.650 (16.51)	5%	HRS513BP394J6*10	219 -	220 -
T or M49470P01474JE*	0.47	1	.360 (9.14)	5%	HRS319BP474J6*20	221 -	222 -
T or M49470P01564JE*	0.56	1	.480 (12.19)	5%	HRS419BP564J6*20	223 -	224 -
T or M49470P01684JE*	0.68	1	.480 (12.19)	5%	HRS419BP684J6*20	225 -	226 -
T or M49470P01824JE*	0.82	1	.650 (16.51)	5%	HRS519BP824J6*20	227 -	228 -
T or M49470P01105JE*	1	2	.480 (12.19)	5%	HRS415BP105J6*15	229 -	230 -
T or M49470P01125JE*	1.2	2	.650 (16.51)	5%	HRS515BP125J6*15	231 -	232 -
T or M49470P01155JE*	1.5	6	.360 (9.14)	5%	HRS318BP155J6*20	233 -	234 -
T or M49470P01185JE*	1.8	6	.480 (12.19)	5%	HRS418BP185J6*20	235 -	236 -
T or M49470P01225JE*	2.2	6	.650 (16.51)	5%	HRS518BP225J6*20	237 -	238 -

Note 1: Asterisk (*) refers to lead style N through K; consult factory or DLA website for qualification status.

Note 2: Parts can also be ordered with 10% or 20% cap tolerance; include "K" or "M" in the Presidio part number. Example: HRS313BP274K6*10

MIL-PRF-49470 QPL STANDARD PROFILE PART NUMBER

T49470

P

01

394

J

E

K

Product Level
for Level B, use M
for Level T, use T

Dielectric
Characteristic
(BP)
See page 10

Performance
Specification
Slash Sheet Number
Indicating
MIL-PRF-49470/1&2

Capacitance
Value (in picofarads):
Two significant figures
followed by the number of
zeros. Examples:
103 = 10,000 pF = .01 µF
394 = 390,000 pF = 0.39 µF

Capacitance
Tolerance
J = 5% (BP Only)
K = 10%
M = 20%

Rated Voltage
(Z, A, B, C, E)

Lead
Configuration
(N, L, M, J, K)



MIL-PRF-49470 LOW PROFILE (BP) REDUCED HEIGHT — LARGER CASE SIZE

MIL-PRF-49470 (Change J to K for 10% Tol.)	Cap µF	Case Code	Height A inches (mm)	Cap Tol. 5%	Presidio Part No. (Change J to K for 10% Tol.)	
Blue Fill = T Level		Bold = M Level		50 VOLT (A)		
BP	T or M49470P01184JA*	0.18	4	.240 (6.10)	5%	HRS205BP184J2*4
	T or M49470P01224JA*	0.22	4	.240 (6.10)	5%	HRS205BP224J2*4
	T or M49470P01274JA*	0.27	4	.240 (6.10)	5%	HRS205BP274J2*4
	T or M49470P01564JA*	0.56	3	.240 (6.10)	5%	HRS213BP564J2*10
	T or M49470P01225JA*	2.2	2	.240 (6.10)	5%	HRS215BP225J2*15
	T or M49470P01275JA*	2.7	2	.240 (6.10)	5%	HRS215BP275J2*15
	T or M49470P01335JA*	3.3	2	.360 (9.14)	5%	HRS315BP335J2*15
	T or M49470P01395JA*	3.9	2	.360 (9.14)	5%	HRS315BP395J2*15
T or M49470P01475JA*	4.7	2	.480 (12.19)	5%	HRS415BP475J2*15	
Blue Fill = T Level		Bold = M Level		100 VOLT (B)		
BP	T or M49470P01154JB*	0.15	4	.240 (6.10)	5%	HRS205BP154J3*4
	T or M49470P01184JB*	0.18	4	.240 (6.10)	5%	HRS205BP184J3*4
	T or M49470P01224JB*	0.22	4	.240 (6.10)	5%	HRS205BP224J3*4
	T or M49470P01474JB*	0.47	3	.240 (6.10)	5%	HRS213BP474J3*4
	T or M49470P01564JB*	0.56	3	.240 (6.10)	5%	HRS213BP564J3*10
	T or M49470P01185JB*	1.8	2	.240 (6.10)	5%	HRS215BP185J3*15
	T or M49470P01335JB*	3.3	2	.480 (12.19)	5%	HRS415BP335J3*15
Blue Fill = T Level		Bold = M Level		200 VOLT (C)		
BP	T or M49470P01683JC*	0.068	4	.120 (3.05)	5%	HRS105BP683J4*4
	T or M49470P01823JC*	0.082	4	.240 (6.10)	5%	HRS205BP823J4*4
	T or M49470P01104JC*	0.1	4	.240 (6.10)	5%	HRS205BP104J4*4
	T or M49470P01274JC*	0.27	3	.240 (6.10)	5%	HRS213BP274J4*10
	T or M49470P01824JC*	0.82	2	.240 (6.10)	5%	HRS215BP824J4*15
	T or M49470P01105JC*	1	2	.240 (6.10)	5%	HRS215BP105J4*15
	T or M49470P01125JC*	1.2	2	.360 (9.14)	5%	HRS315BP125J4*15
	T or M49470P01155JC*	1.5	2	.360 (9.14)	5%	HRS315BP155J4*15
	T or M49470P01185JC*	1.8	2	.480 (12.19)	5%	HRS415BP185J4*15
Blue Fill = T Level		Bold = M Level		500 VOLT (E)		
BP	T or M49470P01333JE*	0.033	4	.240 (6.10)	5%	HRS205BP333J6*4
	T or M49470P01393JE*	0.039	4	.240 (6.10)	5%	HRS205BP393J6*4
	T or M49470P01473JE*	0.047	4	.360 (9.14)	5%	HRS305BP473J6*4
	T or M49470P01124JE*	0.12	3	.240 (6.10)	5%	HRS213BP124J6*10
	T or M49470P01394JE*	0.39	2	.240 (6.10)	5%	HRS215BP394J6*15
	T or M49470P01474JE*	0.47	2	.240 (6.10)	5%	HRS215BP474J6*15
	T or M49470P01564JE*	0.56	2	.360 (9.14)	5%	HRS315BP564J6*15
	T or M49470P01684JE*	0.68	2	.360 (9.14)	5%	HRS315BP684J6*15
	T or M49470P01824JE*	0.82	2	.480 (12.19)	5%	HRS415BP824J6*15
	T or M49470P01225JE*	2.2	6	.480 (12.19)	5%	HRS415BP225J6*20

PRESIDIO'S MIL-PRF-49470 LOW PROFILE CAPACITORS

Asterisk in Part Number (*) refers to lead style A — F. Consult factory or DLA website for qualification status.

For these parts "low profile" indicates the height has been reduced by using a larger case code and reducing the number of chips per stack.

Presidio is a world leader in the manufacturing of ceramic stacked capacitors. We can optimize our design for the foot print and height available on your board. We are easy to reach.

Please contact our engineering team at
+1-858-578-9390
or email us at info@presidiocomponents.com.

49470 LOW PROFILE LEADS

49470 Lead Symbol (Last Digit of P/N)	Lead Style	Stack Height Profile (Dimension A)	Formed Lead Height inches (mm)
A	N (straight)	Low	N/A
B	L (formed)	Low	.070 ± .010 (1.78 ± 0.25)
D	L (formed)	Low	.045 ± .010 (1.14 ± 0.25)
C	J (formed)	Low	.070 ± .010 (1.78 ± 0.25)
F	J (formed)	Low	.045 ± .010 (1.14 ± 0.25)

49470 LOW PROFILE DIMENSIONS

49470 Case Code	C ± .025 in. (± .64 mm)	D inches (mm)		E (max.) inches (mm)	Number of Leads per Side
		Min.	Max.		
1	.450 (11.43)	1.950 (49.53)	2.075 (52.71)	.500 (12.70)	20
2	.800 (20.32)	1.450 (36.83)	1.535 (38.99)	.870 (22.10)	15
3	.450 (11.43)	.950 (24.13)	1.075 (27.31)	.500 (12.70)	10
4	.400 (10.16)	.350 (8.89)	.425 (10.80)	.440 (11.18)	4
5	.250 (6.35)	.224 (5.69)	.275 (6.99)	.300 (7.62)	3
6	1.250 (31.75)	1.950 (49.53)	2.075 (52.71)	1.350 (34.29)	20

M & T LEVEL 49470 LOW PROFILE LEAD STYLE AND DIMENSIONS

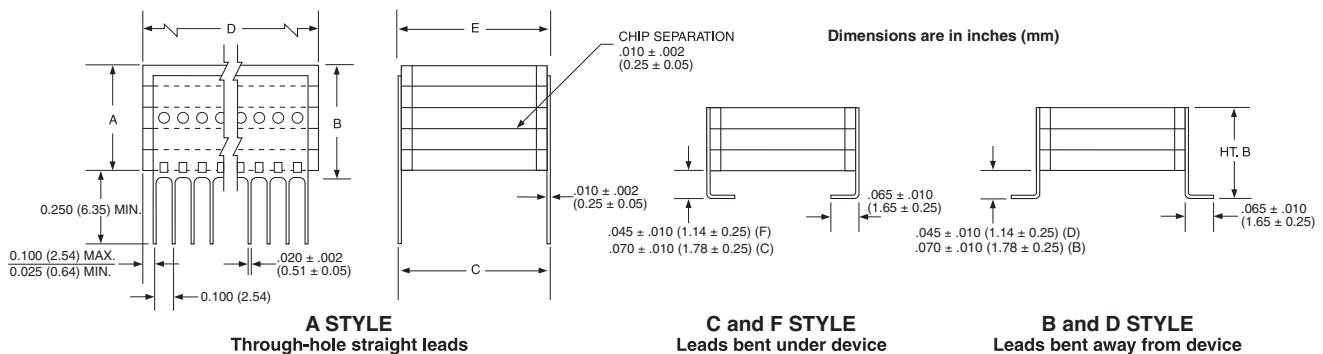

MIL-PRF-49470 QPL LOW PROFILE PART NUMBER

T49470	P	01	104	J	C	D
Product Level for Level B, use M for Level T, use T	Dielectric Characteristic (P) See page 10	Performance Specification Slash Sheet Number Indicating MIL-PRF-49470/1&2	Capacitance Value (in picofarads): Two significant figures followed by the number of zeros. Examples: 103 = 10,000 pF = .01 µF 104 = 100,000 pF = 0.1 µF	Capacitance Tolerance J = 5% (BP Only) K = 10% M = 20%	Rated Voltage (Z, A, B, C, E)	Lead Configuration (A, B, D, C, F)

NOTES

MIL-PRF-49470 ELECTRICAL & PERFORMANCE CHARACTERISTICS (ALL CHARACTERISTICS & TEST METHODS IAW MIL-PRF-49470)

ELECTRICAL CHARACTERISTICS

Dielectric Type	Rated Voltage (V)	Temperature Coefficient (TC) from -55° to +125°C Bias = 0 Volt	Temperature Voltage Coefficient (VTC) from -55° to +125°C Bias = Rated Voltage
BP	ALL	± 30 PPM	± 30 PPM
BX	25/50/100	±15%	+15, -25%
BR	200	±15%	+15, -40%
BQ	500	±15%	+15, -50%

Capacitance: Measured at 1.0 volt (open circuit) and 1KHz. See tables on pages 2 through 5.

Capacitance Tolerance: J = ±5%, K = ±10%, M = ±20%. *

Dissipation Factor: When tested at 1.0 volt (open circuit) and 1KHz, BP characteristic shall be .15% maximum and BX/BR/BQ characteristic shall be 2.5% maximum.

Dielectric Withstanding Voltage: Dielectric withstanding voltage will be tested at 250% of rated voltage except for 500V rated parts which will be tested at 150% of rated voltage.

Insulation Resistance:

At +25°C, rated voltage: $10^{11} \Omega$ or $1000 \text{ M}\Omega\text{-}\mu\text{F}$, whichever is less.

At +125°C, rated voltage: $10^{10} \Omega$ or $100 \text{ M}\Omega\text{-}\mu\text{F}$, whichever is less.

PERFORMANCE CHARACTERISTICS AND TEST METHODS (M49470 PART NUMBERS)

Operating Temperature Range: The operating temperature range is -55°C to +125°C.

Thermal Shock: All parts are cycled between -55°C and +125°C, 5 times.

Voltage Conditioning: All parts are tested for 96 hours at 125°C and 200% of rated voltage except 500V rated parts are tested at 120% of rated voltage. The overall percent defective allowed (PDA) is 10%.

Solderability: Meets Mil-STD-202 and J-STD-001 requirements.

Resistance to Soldering Heat: Parts withstand 260°C for 10 seconds with no degradation in electrical performance or lead attachment.

Terminal Strength: Leads will withstand 5 pounds (4 pounds for case code 5) of applied force without rupturing.

Moisture Resistance: Periodically parts are tested for 20 cycles at 90% RH and between -10°C to +65°C. Bias is applied during the first 10 cycles.

Life: Not required for each lot. Every 3 months, a minimum of 12 pieces are tested for 1000 hours at +125°C and 200% of rated voltage, except 500V rated parts shall be tested at 120% of rated voltage.

Barometric Pressure: Parts will operate at rated voltage (80% of rated voltage for 500 volt parts) at reduced pressure up to 100,000 feet.

Shock, Specified Pulse: Parts remain operational during and after impacts of 100 G's.

Vibration: Parts remain operational during and after operating in high vibration environments of up to 20 G's.

Marking: Marking shall be in accordance with Mil-STD-1285 and Mil-PRF-49470. Minimum marking will be "JB", manufacturer's code (PCI), capacitance and tolerance, and date code. Full marking will be included on the package.

Cage Code 60212: Presidio Components, Inc.

ADDITIONAL REQUIREMENTS (T49470 PART NUMBERS)

Ultrasonic Imaging: All parts are imaged during in-process testing to remove voids and delaminations IAW EIA 469.

Destructive Physical Analysis: A sample of chips is examined prior to assembly for defects in the microstructure. As part of Group A, an additional sample is examined for cracks or assembly defects.

Thermal Shock: Prior to voltage conditioning, all parts are cycled between -55°C and +125°C, 20 times. Prior to life test sample pieces receive 100 cycles under conditions outlined above.

Voltage Conditioning: All parts are tested for 168 - 264 hours at 125°C and 200% of rated voltage except 500V rated parts are tested at 120% of rated voltage. The overall percent defective allowed (PDA) is 5% for case codes 4 and 5 and 8% for all other case codes. The PDA in the last 48 hours of voltage conditioning is .5% for case codes 4 and 5, and 1% for all other case codes, or 1 piece whichever is greater.

Life: For qualification, parts are tested for 4000 hours at +125°C and 200% of rated voltage except 500V rated parts shall be tested at 120% of rated voltage. For each lot, 12 pieces are tested for a 1000 hours under conditions outlined above.

Humidity, Steady State, Low Voltage: Six pieces are tested from each lot at 1.3 volts, 85% RH and 85°C, to ensure the absence of low voltage failure mechanisms. These mechanisms include microcracking.

Marking: Parts will be marked as M49470 parts except "JB" is replaced with "JT".

* Unless otherwise specified.

J Tolerance for BP only. Customer SCD takes precedence.

MIL-PRF-49470 FREQUENCY RESPONSE CURVES

DOWNLOADABLE GRAPHS IN PDF FORMAT

VISIT our library
of Power Supply Capacitors
Frequency Response Curves

LOG ON TO PRESIDIO'S WEBSITE AT:
www.presidiocomponents.com/curves

All graphs in PDF format for easy viewing.
Please Contact Factory for Additional Data.

10µF, 50 VOLT M49470X01106_A
PRESIDIO PN S405BX106_2_4

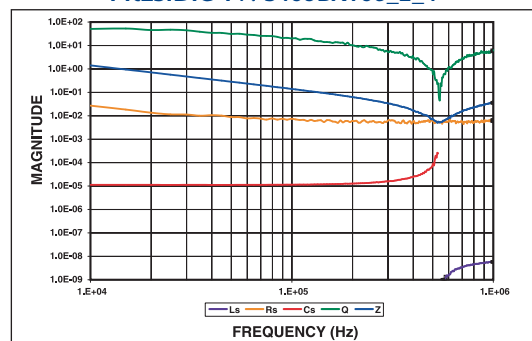

PRESIDIO COMPONENTS, INC.

AVAILABLE TEST ROUTINES

	Presidio Standard (All Test Methods IAW Mil-PRF-49470)			DLA Standard (Defense Logistics Agency)	
	Commercial	“HR” Stack	“SR” Stack	Mil-PRF-49470 B/M Level	Mil-PRF-49470 T Level
Description	For Commercial Applications	Similar to Mil-PRF-49470 B/M Level or Per SCD	Similar to Mil-PRF-49470 T Level or Per SCD	High Reliability Military	High Reliability Space
Chip DPA	Yes Presidio Internal Requirement	Yes Presidio Internal Requirement	Yes Presidio Internal Requirement	Not Required	Yes Specification Requirement
Ultrasonic Imaging C-Scan	Not Required	Not Required or per SCD	Optional	Not Required	Required
Thermal Shock As Part Of Group A	Not Required	Optional	20 Cycles or per SCD	5 Cycles	20 Cycles
Voltage Conditioning (Duration)	Not Required	8 Hours Min. or per SCD	168 - 264 Hours	96 Hours	168 - 264 Hours
Visual/100% Electrical (Cap/DF/IR/DWV)	Yes	Yes	Yes	Yes	Yes
IR 125°C	Not Required	Optional	Optional	Required	Required
Stack DPA	Not Required	Not Required or per SCD	Optional	Not Required	Required
Life Test	Not Required	Optional	Optional	Not Required on Lot Basis	Yes - Includes 100 Thermal Shock Cycles
Humidity, Steady State, Low Voltage	Not Required	Not Required or per SCD	Optional	Not Required	Yes
Mil-STD-790 Approved Facility	Yes	Yes	Yes	Yes	Yes

SOLDERING RECOMMENDATIONS FOR CERAMIC STACKED CAPACITORS

The following are general recommendations for soldering of ceramic stacked capacitors. In general, Presidio Components recommends against hand soldering for this type of large ceramic device. However, if hand soldering cannot be avoided, it should be done with care to avoid thermally cracking the parts. Soldering of these parts to the circuit board, if done in a careless manner, is the most likely source of reliability problems.

PREHEATING AND MOUNTING. For reflow soldering, the parts should be preheated to within 50°C - 60°C of the reflow temperature, or as close as is practical. A convection-style reflow oven with nitrogen is ideal, but other types of reflow will also work. The heat-up and cool-down rates (dT/dt) should be kept well under 4°C/sec. and preferably under 2°C/sec. After soldering, allow the parts to air cool to room temperature before cleaning.

Note: Presidio Components’ parts are designed to reliably withstand reflow temperatures of 265°C maximum. If higher temperature reflow is required, consult factory.

HAND SOLDERING. If hand soldering must be used, preheat the parts as recommended above. A hot-air gun is an ideal tool for preheating. When hand soldering, avoid excessive heat, and keep the tip of the soldering iron as far away from the ceramic as possible.

As an example, for through-hole leaded parts, solder from the backside of the board. This will minimize the risk of thermally

cracking the ceramic. After soldering, allow the parts to air cool to room temperature before cleaning.

PRE-TINNING LEADS. The leads do not need to be pre-tinned as they have already been tinned with Sn63 as part of our process.

In addition to the above, the following rules apply:

1. Do not dip stacked capacitors into a solder pot (to pre-tin, for example).
2. Do not touch-up a solder joint with a soldering iron. If touch up is necessary follow preheating and hand soldering recommendations above.
3. Do not deform leads or use excessive force to install parts.

Further, in accordance with Mil-PRF-49470, the following precaution should be followed:

“Precautionary Note: Capacitors covered by this specification sheet are very susceptible to thermal shock damage due to their large ceramic mass. Temperature profiles used should provide adequate temperature rise and cool-down time to prevent damage from thermal shock.”

DISCLAIMER: THE INFORMATION IN THIS CATALOG IS SUBJECT TO CHANGE WITHOUT NOTICE. PLEASE CHECK RELEVANT DLA SPECIFICATIONS.



CERAMIC STACKED CAPACITORS

X7R AND NPO MAXIMUM CAPACITANCE (µF)

Many other case sizes available.
Please contact factory.

Most popular sizes
shown in yellow

Ex: HRS208X7R245K2J2
(2.4µF, 50V, .220" total height)

PRESIDIO CASE SIZE CODE																				"B" Ht. Max. inch (mm)	No. of Chips per Stack		
Case Code	08		17		32		36		16		01		47		42		21		06				
Dielectric	X7R	NPO	X7R	NPO	X7R	NPO	X7R	NPO	X7R	NPO	X7R	NPO	X7R	NPO	X7R	NPO	X7R	NPO	X7R	NPO			
25V (Voltage Code=1)	1.4	.036	1.8	.045	2.0	.050	2.0	.050	2.3	.060	2.5	.065	3.0	.080	3.0	.080	3.9	.10	5.0	.13	.150 (3.81)	1	
	2.8	.072	3.6	.090	4.0	.10	4.0	.10	4.6	.12	5.0	.13	6.0	.16	6.0	.16	7.8	.20	10	.26	.200 (5.08)	2	
	4.2	.11	5.4	.13	6.0	.15	6.0	.15	6.9	.18	7.5	.19	9.0	.24	9.0	.24	11	.30	15	.39	.275 (6.99)	3	
	—	—	7.2	.18	—	—	—	—	—	9.2	.24	10	.26	12	.32	12	—	15	.40	20	.52	.350 (8.89)	4
	—	—	9.0	.22	—	—	—	—	—	11	.30	12	.32	15	.40	15	—	19	.50	25	.65	.425 (10.80)	5
—	—	11	.27	—	—	—	—	—	14	.36	15	.39	18	.48	18	—	23	.60	30	.78	.500 (12.70)	6	
50V (Voltage Code=2)	1.2	.030	1.5	.040	1.7	.040	1.7	.040	1.9	.050	2.1	.055	2.7	.070	2.7	.070	3.3	.080	4.5	.11	.150 (3.81)	1	
	2.4	.060	3.0	.080	3.4	.080	3.4	.080	3.8	.10	4.2	.11	5.4	.14	5.4	.14	6.6	.16	9.0	.22	.220 (5.59)	2	
	3.6	.090	4.5	.12	5.1	.12	5.1	.12	5.7	.15	6.3	.16	8.1	.21	8.1	.21	10	.24	13	.33	.310 (7.87)	3	
	—	—	6.0	.16	—	—	—	—	—	7.6	.20	8.4	.22	10	.28	10	—	13	.32	18	.44	.400 (10.16)	4
	—	—	7.5	.20	—	—	—	—	—	9.5	.25	10	.27	13	.35	13	—	16	.40	22	.55	.490 (12.45)	5
75V See Note 2	—	—	—	—	—	—	—	—	11	.30	12	.33	16	.42	16	—	19	.48	27	.66	.580 (14.73)	6	
100V (Voltage Code=3)	.75	.020	1.0	.025	1.1	.030	1.1	.030	1.2	.035	1.4	.040	1.8	.050	1.8	.050	2.2	.060	3.0	.080	.160 (4.06)	1	
	1.5	.040	2.0	.050	2.2	.060	2.2	.060	2.4	.070	2.8	.080	3.6	.10	3.6	.10	4.4	.12	6.0	.16	.280 (7.11)	2	
	—	—	3.0	.075	—	—	—	—	—	3.6	.10	4.2	.12	5.4	.15	5.4	—	6.6	.18	9.0	.24	.400 (10.16)	3
	—	—	4.0	.10	—	—	—	—	—	4.8	.14	5.6	.16	7.2	.20	7.2	—	8.8	.24	12	.32	.520 (13.21)	4
	—	—	—	—	—	—	—	—	—	6.0	.17	7.0	.20	9.0	.25	9.0	—	11	.30	15	.40	.640 (16.26)	5
—	—	—	—	—	—	—	—	—	—	—	—	—	—	—	—	—	—	—	—	—	.760 (19.30)	6	
200V (Voltage Code=4)	0.22	.012	0.3	.016	.36	.018	.36	.018	.39	.020	0.42	.022	.60	.027	.60	.030	.70	.036	1.0	.047	.160 (4.06)	1	
	0.44	.024	0.6	.032	.72	.036	.72	.036	.78	.040	0.84	.044	1.2	.054	1.2	.060	1.4	.072	2.0	.094	.280 (7.11)	2	
	—	—	0.9	.048	—	—	—	—	—	1.1	.060	1.2	.066	1.8	.071	1.8	—	2.1	.11	3.0	.14	.400 (10.16)	3
	—	—	1.2	.064	—	—	—	—	—	1.5	.080	1.7	.088	2.4	.11	2.4	—	2.8	.14	4.0	.19	.520 (13.21)	4
	—	—	—	—	—	—	—	—	—	1.9	.10	2.1	.11	3.0	.13	3.0	—	3.5	.18	5.0	2.3	.640 (16.26)	5
—	—	—	—	—	—	—	—	—	—	—	—	—	—	—	—	—	—	—	—	—	.760 (19.30)	6	
500V (Voltage Code=6)	0.11	.0060	0.14	.0075	.15	.0080	.15	.0080	0.18	.010	0.19	.011	.25	.013	.25	.013	.30	.016	.42	.022	.160 (4.06)	1	
	0.22	.012	0.28	.015	.30	.016	.30	.016	0.36	.020	0.38	.022	.50	.026	.50	.026	.60	.032	.84	.044	.280 (7.11)	2	
	—	—	0.42	.022	—	—	—	—	—	0.54	.030	0.57	.033	.75	.039	.75	—	.90	.048	1.2	.066	.400 (10.16)	3
	—	—	0.56	.030	—	—	—	—	—	0.72	.040	0.76	.044	1.0	.052	1.0	—	1.2	.064	1.6	.088	.520 (13.21)	4
	—	—	—	—	—	—	—	—	—	0.90	.050	0.95	.055	1.2	.065	1.2	—	1.5	.080	2.1	.11	.640 (16.26)	5
—	—	—	—	—	—	—	—	—	—	—	—	—	—	—	—	—	—	—	—	—	.760 (19.30)	6	
Dimensions inches (mm)	.215 (5.46)		.185 (4.70)		.300 (7.62)		.355 (9.02)		.235 (5.97)		.275 (6.99)		.310 (7.87)		.400 (10.16)		.300 (7.62)		.375 (9.53)		C ± .025 (0.64)		
	.215 (5.46)		.275 (6.99)		.180 (4.57)		.150 (3.81)		.275 (6.99)		.275 (6.99)		.270 (6.86)		.220 (5.59)		.330 (8.38)		.375 (9.53)		D (Max) Width		
	.240 (6.10)		.210 (5.33)		.325 (8.26)		.380 (9.65)		.260 (6.60)		.300 (7.62)		.335 (8.51)		.425 (10.80)		.325 (8.26)		.400 (10.16)		E (Max) Length		
Leads per Side	2		3		2		2		3		3		3		2		3		4		Height dimensions based on commonly ordered parts. Optimized heights available.		
Chip Size	2018		1725		2917		3415		2225		2627		3026		3920		2832		3736				

Presidio's most popular sizes are highlighted. Choose these for best price, delivery and availability.

Notes:

- "B" height dimensions are based on commonly ordered parts. Optimized heights are available.
- 75V parts are also available. Capacitance values of 75V parts are half-way between 50V and 100V parts. Lower, intermediate and higher voltages available (i.e. 16V, 150V, 300V, 600V, etc).
- Vertical stacks are sometimes useful for reducing the footprint; for availability, consult factory.
- Other sizes, capacitances, lead frames, dielectrics (BP, BX, BR, BQ), and voltage ratings are available. Consult factory.

HOW TO ORDER OUR CERAMIC STACKED CAPACITORS

HR	S	5	01	X7R	106	K	2	J	3
Optional Screening Code	Configuration	No. of Chips	Case Code	Dielectric Type	Capacitance Code	Capacitance Tolerance *	Voltage Code	Lead Frame Style	No. of Leads
Leave Blank for Commercial HR SR (See pg. 7)	Stacked Capacitor Assembly	Number of Chips per Stack	See Above	X7R NPO	Capacitance (in picofarads): Two significant figures followed by the number of zeros. Examples: 103=10,000 pF=.01 µF 106=10,000,000 pF=10 µF	F = ±1% (NPO only) G = ±2% (NPO only) J = ±5% (NPO only) K = ±10% M = ±20% Z = -20% /+80%	1 = 25V 2 = 50V 3 = 100V 4 = 200V 6 = 500V	J = Leads formed under G = Leads formed out N = Through-hole S = See pages 12 & 13	Number of Leads per Side (See Above)

* Unless otherwise specified.
Customer SCD takes precedence.



CERAMIC STACKED CAPACITORS

X7R AND NPO

MAXIMUM CAPACITANCE (µF)

Many other case sizes available.
Please contact factory.

Ex: HRS205NP0324K1J4
(.32µF, 25V, .200" total height)

PRESIDIO CASE SIZE CODE																		"B" Ht. Max. inch (mm)	No. of Chips per Stack	
Case Code	02		03		07		37		05		04		48		44		13			
Dielectric	X7R	NPO	X7R	NPO	X7R	NPO	X7R	NPO	X7R	NPO	X7R	NPO	X7R	NPO	X7R	NPO	X7R	NPO		
25V (Voltage Code=1)	5.6	.14	6.0	.15	6.5	.17	6.5	.17	7.0	.16	8.0	.20	8.0	.20	13	.33	20	.50	.150 (3.81)	1
	11	.28	12	.30	13	.34	13	.34	14	.32	16	.40	16	.40	26	.66	40	1.0	.200 (5.08)	2
	17	.42	18	.45	19	.51	19	.51	21	.48	24	.60	24	.60	39	1.0	60	1.5	.275 (6.99)	3
	22	.56	24	.60	26	.68	26	.68	28	.64	32	.80	32	.80	52	1.3	80	2.0	.350 (8.89)	4
	28	.70	30	.75	32	.85	32	.85	35	.80	40	1.0	40	1.0	65	1.6	100	2.5	.425 (10.80)	5
	33	.84	36	.90	39	1.0	39	1.0	42	.96	48	1.2	48	1.2	78	2.0	120	3.0	.500 (12.70)	6
50V (Voltage Code=2)	4.7	.12	5.0	.13	5.6	.14	5.6	.14	5.6	.14	6.8	.17	6.8	.17	10	.27	18	.40	.150 (3.81)	1
	9.4	.24	10	.26	11	.28	11	.28	11	.28	13	.34	13	.34	20	.54	36	.80	.220 (5.59)	2
	14	.36	15	.39	16	.42	16	.42	17	.42	20	.51	20	.51	30	.71	54	1.2	.310 (7.87)	3
	19	.48	20	.52	22	.56	22	.56	22	.56	27	.68	27	.68	40	1.1	72	1.6	.400 (10.16)	4
	23	.60	25	.65	28	.70	28	.70	28	.70	34	.85	34	.85	50	1.3	90	2.0	.490 (12.45)	5
	28	.72	30	.78	33	.84	33	.84	33	.84	41	1.0	41	1.0	60	1.6	110	2.4	.580 (14.73)	6
75V See Note 2	3.2	.085	3.3	.090	3.7	.10	3.7	.10	4.0	.10	4.5	.12	4.5	.12	7.0	.20	12	.30	.160 (4.06)	1
100V (Voltage Code=3)	6.4	.17	6.6	.18	7.4	.20	7.4	.20	8.0	.20	9.0	.24	9.0	.24	14	.40	24	.60	.280 (7.11)	2
	9.6	.25	10	.27	11	.30	11	.30	12	.30	13	.36	13	.36	21	.60	36	.90	.400 (10.16)	3
	12	.34	13	.36	15	.40	15	.40	16	.40	18	.48	18	.48	28	.80	48	1.2	.520 (13.21)	4
	16	.42	16	.45	18	.50	18	.50	20	.50	22	.60	22	.60	35	1.0	60	1.5	.640 (16.26)	5
	—	—	—	—	—	—	—	—	—	—	—	—	27	.72	42	1.2	72	1.8	.760 (19.30)	6
	200V (Voltage Code=4)	1.0	.050	1.0	.050	1.2	.060	1.2	.060	1.2	.056	1.5	.075	1.5	.075	2.2	.12	3.5	.18	.160 (4.06)
2.0		.10	2.0	.10	2.4	.12	2.4	.12	2.4	.11	3.0	.15	3.0	.15	4.4	.24	7.0	.36	.280 (7.11)	2
3.0		.15	3.0	.15	3.6	.18	3.6	.18	3.6	.17	4.5	.22	4.5	.22	6.6	.36	10	.54	.400 (10.16)	3
4.0		.20	4.0	.20	4.8	.24	4.8	.24	4.8	.22	6.0	.30	6.0	.30	8.8	.48	14	.72	.520 (13.21)	4
5.0		.25	5.0	.25	6.0	.30	6.0	.30	6.0	.28	7.5	.37	7.5	.37	11	.60	17	.90	.640 (16.26)	5
—		—	—	—	—	—	—	—	—	—	—	—	9.0	.44	13	.72	21	1.1	.760 (19.30)	6
500V (Voltage Code=6)	.44	.024	.46	.025	.50	.027	.50	.027	0.55	.028	.60	.035	.60	.035	1.0	.056	1.6	.080	.160 (4.06)	1
	.88	.048	.92	.050	1.0	.054	1.0	.054	1.1	.056	1.2	.070	1.2	.070	2.0	.11	3.2	.16	.280 (7.11)	2
	1.3	.072	1.3	.075	1.5	.071	1.5	.071	1.6	.084	1.8	.10	1.8	.10	3.0	.16	4.8	.24	.400 (10.16)	3
	1.7	.096	1.8	.10	2.0	.11	2.0	.11	2.2	.11	2.4	.14	2.4	.14	4.0	.22	6.4	.32	.520 (13.21)	4
	2.2	.12	2.3	.12	2.5	.13	2.5	.13	2.7	.14	3.0	.17	3.0	.17	5.0	.28	8.0	.40	.640 (16.26)	5
	—	—	—	—	—	—	—	—	—	—	—	—	3.6	.21	6.0	.33	9.6	.48	.760 (19.30)	6
Dimensions inches (mm)	.350 (8.89)		.415 (10.54)		.375 (9.53)		.550 (13.97)		.400 (10.16)		.475 (12.07)		.400 (10.16)		.375 (9.53)		.450 (11.43)		C ± .025 (0.64)	
	.400 (10.16)		.385 (9.78)		.425 (10.80)		.310 (7.87)		.425 (10.80)		.420 (10.67)		.500 (12.70)		.825 (20.96)		1.075 (27.31)		D (Max) Width	
	.375 (9.53)		.440 (11.18)		.400 (10.16)		.575 (14.61)		.440 (11.18)		.500 (12.70)		.425 (10.80)		.400 (10.16)		.500 (12.70)		E (Max) Length	
Leads per Side	4		4		4		3		4		4		5		8		10		Height dimensions based on commonly ordered parts. Optimized heights available.	
Chip Size	3439		4036		3640		5330		3941		4540		3949		3680		4399			

Presidio's most popular sizes are highlighted. Choose these for best price, delivery and availability.

Notes:

- "B" height dimensions are based on commonly ordered parts. Optimized heights are available.
- 75V parts are also available. Capacitance values of 75V parts are half-way between 50V and 100V parts. Lower, intermediate and higher voltages available (i.e. 16V, 150V, 300V, 600V, etc).
- Vertical stacks are sometimes useful for reducing the footprint; for availability, consult factory.
- Other sizes, capacitances, lead frames, dielectrics (BP, PX, BR, BQ), and voltage ratings are available. Consult factory.

Ex: HRS513X7R805K6G10
(8µF, 500V, .640" total height)

HOW TO ORDER OUR CERAMIC STACKED CAPACITORS

HR	S	4	05	X7R	226	K	2	J	4
Optional Screening Code	Configuration	No. of Chips	Case Code	Dielectric Type	Capacitance Code	Capacitance Tolerance *	Voltage Code	Lead Frame Style	No. of Leads
Leave Blank for Commercial HR SR (See pg. 7)	Stacked Capacitor Assembly	Number of Chips per Stack	See Above	X7R NPO	Capacitance (in picofarads): Two significant figures followed by the number of zeros. Examples: 103=10,000 pF=.01 µF 226=22,000,000 pF=22 µF	F = ± 1% (NPO only) G = ± 2% (NPO only) J = ± 5% (NPO only) K = ± 10% M = ± 20% Z = -20% /+80%	1 = 25V 2 = 50V 3 = 100V 4 = 200V 6 = 500V	J = Leads formed under G = Leads formed out N = Through-hole S = See pages 12 & 13	Number of Leads per Side (See Above)

* Unless otherwise specified. Customer SCD takes precedence.



PRESIDIO COMPONENTS, INC.

7169 Construction Court, San Diego, CA 92121 USA • Tel: +1-858-578-9390 • Fax: +1-858-578-6225
www.presidiocomponents.com • info@presidiocomponents.com

HIGH VOLTAGE STACKED CAPACITORS

Ex: HRS156NP0303K9J6
(.03µF, 1KV, .200" total height)

PRESIDIO COMMON SIZES - X7R AND NPO
MAXIMUM CAPACITANCE (µF)

Ex: HRS358X7R214K13N6
(.21µF, 3KV, .500" total height)

PRESIDIO CASE SIZE CODE																"B" Ht. Max. inch (mm)	No. of Chips per Stack	
Case Code	52		53		37		54		55		56		57		58			
Dielectric	X7R	NPO	X7R	NPO	X7R	NPO	X7R	NPO	X7R	NPO	X7R	NPO	X7R	NPO	X7R	NPO		
1000V (Voltage Code=9)	.040	.0036	.080	.0075	.12	.010	.16	.014	.25	.022	.35	.030	.38	.033	.70	.060	.200 (5.08)	1
	.080	.0072	.16	.015	.24	.020	.32	.028	.50	.044	.70	.060	.76	.066	1.4	.12	.350 (8.89)	2
	.12	.011	.24	.022	.36	.030	.48	.042	.75	.066	1.0	.090	1.1	.10	2.1	.18	.500 (12.70)	3
	.16	.014	.32	.030	.48	.040	.64	.056	1.0	.088	1.4	.12	1.5	.13	2.8	.24	.650 (16.51)	4
2000V (Voltage Code=11)	.0080	.00075	.019	.0017	.027	.0024	.035	.0032	.055	.0050	.080	.0070	.090	.0082	.17	.015	.200 (5.08)	1
	.016	.0015	.038	.0034	.054	.0048	.070	.0064	.11	.010	.16	.014	.18	.016	.34	.030	.350 (8.89)	2
	.024	.0022	.057	.0051	.081	.0072	.10	.0096	.16	.015	.24	.021	.27	.024	.51	.045	.500 (12.70)	3
	.032	.0030	.076	.0068	.10	.0096	.14	.013	.22	.020	.32	.028	.36	.033	.68	.060	.650 (16.51)	4
3000V (Voltage Code=13)	—	—	.0070	.00065	.011	.0010	.014	.0013	.022	.0021	.033	.0030	.039	.0035	.070	.0065	.200 (5.08)	1
	—	—	.014	.0013	.022	.0020	.028	.0026	.044	.0042	.066	.0060	.078	.0070	.14	.013	.350 (8.89)	2
	—	—	.021	.0019	.033	.0030	.042	.0039	.066	.0063	.10	.0090	.11	.010	.21	.019	.500 (12.70)	3
	—	—	.028	.0026	.044	.0040	.056	.0052	.088	.0084	.13	.012	.15	.014	.28	.026	.650 (16.51)	4
4000V (Voltage Code=14)	—	—	—	—	.0055	.00050	.007	.00060	.012	.0010	.017	.0015	.020	.0018	.039	.0035	.200 (5.08)	1
	—	—	—	—	.011	.0010	.014	.0012	.024	.0020	.034	.0030	.040	.0036	.078	.0070	.350 (8.89)	2
	—	—	—	—	.016	.0015	.021	.0018	.036	.0030	.051	.0045	.060	.0054	.11	.010	.500 (12.70)	3
	—	—	—	—	.022	.0020	.028	.0024	.048	.0040	.068	.0060	.080	.0072	.15	.014	.650 (16.51)	4
5000V (Voltage Code=15)	—	—	—	—	.0030	.00033	.0040	.00042	.0065	.00070	.0090	.0010	.011	.012	.022	.0024	.200 (5.08)	1
	—	—	—	—	.0060	.00066	.0080	.00084	.013	.0014	.018	.0020	.022	.024	.044	.0048	.350 (8.89)	2
	—	—	—	—	.0090	.0010	.012	.0012	.019	.0021	.027	.0030	.033	.036	.066	.0072	.500 (12.70)	3
	—	—	—	—	.012	.0013	.016	.0016	.026	.0028	.036	.0040	.044	.048	.088	.0096	.650 (16.51)	4
Dimensions inches (mm)	.300 (7.62)		.415 (10.54)		.550 (13.97)		.500 (12.70)		.600 (15.24)		.700 (17.78)		.975 (24.77)		1.375 (34.93)		C ± .025 (0.64)	
	.260 (6.60)		.350 (8.89)		.320 (8.13)		.460 (11.68)		.560 (14.22)		.660 (16.76)		.520 (13.21)		.670 (17.02)		D (Max) Width	
	.325 (8.26)		.440 (11.18)		.580 (14.73)		.525 (13.34)		.625 (15.88)		.725 (18.42)		1.000 (25.40)		1.400 (35.56)		E (Max) Length	
Leads per Side	3		4		3		4		5		6		5		6		Height dimensions based on commonly ordered parts. Optimized heights available.	
Chip Size	2824		3933		5330		4844		5854		6864		9650		13565			

Note: Other sizes, capacitances, lead frames, and voltage ratings are available. Consult factory.

PRESIDIO LEAD STYLE AND DIMENSIONS

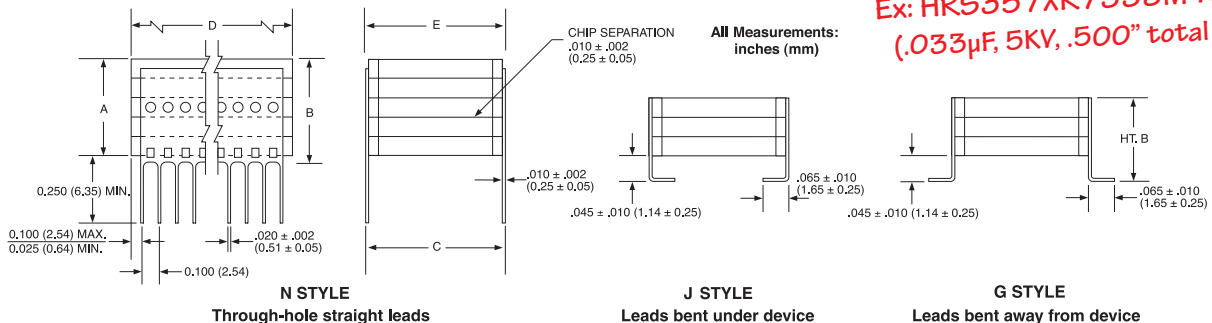

Ex: HRS357XR7333M15G5
(.033µF, 5KV, .500" total height)

HOW TO ORDER OUR HIGH VOLTAGE STACKED CAPACITORS

HR	S	3	52	X7R	124	K	9	J	3
Optional Screening Code	Configuration	No. of Chips	Case Code	Dielectric Type	Capacitance Code	Capacitance Tolerance *	Voltage Code	Lead Frame Style	No. of Leads
Leave Blank for Commercial HR SR (See pg. 7)	Stacked Capacitor Assembly	Number of Chips per Stack	See Above	X7R NPO	Capacitance (in picofarads): Two significant figures followed by the number of zeros. Examples: 103=10,000 pF=.01 µF 124=120,000 pF=.12 µF	F = ± 1% (NPO only) G = ± 2% (NPO only) J = ± 5% (NPO only) K = ± 10% M = ± 20% Z = -20% /+80%	9 = 1000V 11 = 2000V 13 = 3000V 14 = 4000V 15 = 5000V	J = Leads formed under G = Leads formed out N = Through-hole S = See pages 12 & 13	Number of Leads per Side (See Above)

* Unless otherwise specified.
Customer SCD takes precedence.

PRESIDIO COMPONENTS, INC.

7169 Construction Court, San Diego, CA 92121 USA • Tel: +1-858-578-9390 • Fax: +1-858-578-6225

www.presidiocomponents.com • info@presidiocomponents.com

HIGH FREQUENCY-HIGH POWER CAPACITORS FOR AC LINE FILTERING OR HIGH POWER RF APPLICATIONS TYPE N2200 DIELECTRIC

APPLICATIONS:

- AC line filtering, typically from 110-230 volts AC, 80 to 400 Hz
- High power RF at high voltages, 500 volts to 5,000 volts

FEATURES:

- Low dissipation factor (DF)
- Low self-heating
- Low ESR over a wide frequency range
- High reliability
- Stable capacitance vs frequency
- No aging rate

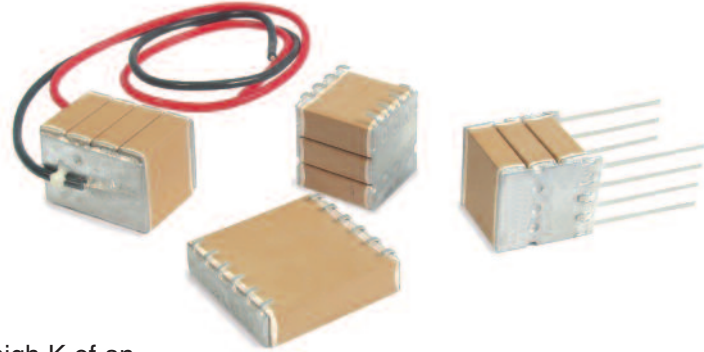

CERAMIC TYPE:

- Type N2200, NTC dielectric (combines the high K of an X7R dielectric with the stability of an NPO dielectric)
- Temperature coefficient: -55°C to 25°C: -3330 ppm/°C max. change, no min.
25°C to 125°C: -2700 ppm/°C max. change, no min.
- N2200 Dielectric code is "N2T"

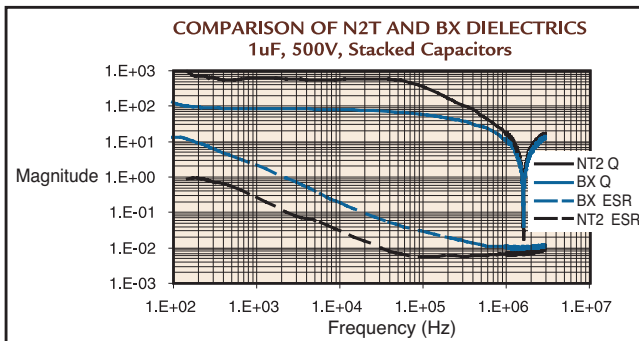
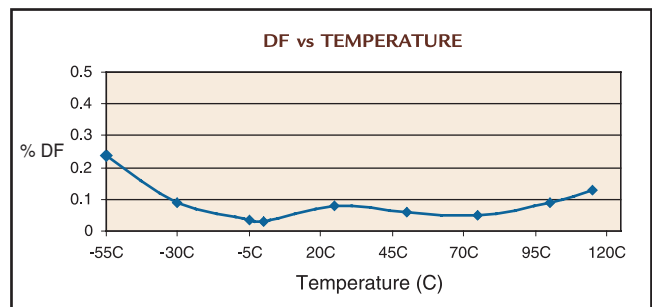
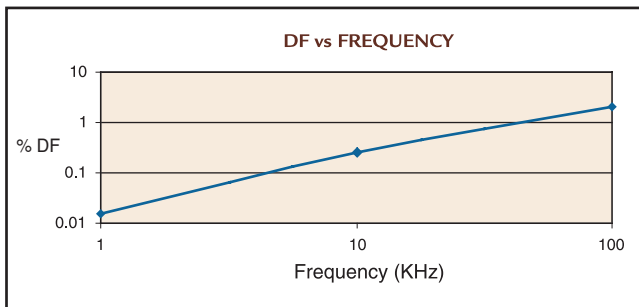
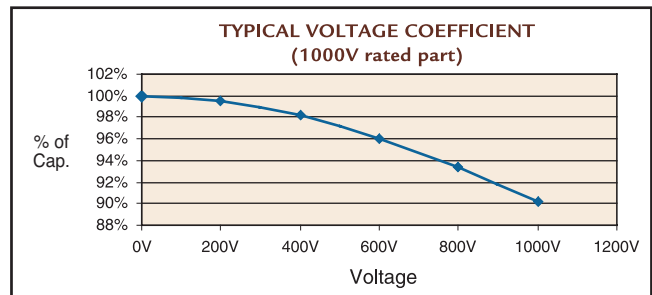
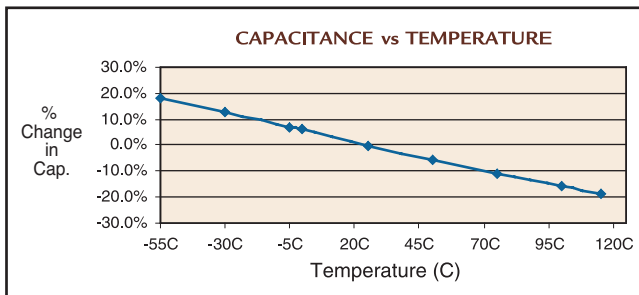

POPULAR PART NUMBERS		
Capacitance	Voltage	Part Number
.068 μ F	500 V	RL2422N2T683K6E250
.330 μ F	500 V	RL3941N2T334K6E400
1 μ F	500 V	S405N2T105K6N4
.050 μ F	1000 V	RL3736N2T503K9E375
.015 μ F	5000 V	RL8557N2T153K15E850

Notes: 1. Capacitors available as radial leaded or stacked.
2. Other sizes, capacitances, lead frames, dielectrics (BP, BX, BR, BQ), & voltage ratings are available. Consult factory.



LOW PROFILE 'S' LEAD CAPACITORS

LOW PROFILE · LOW STANDOFF

APPLICATIONS:

- Industrial
- Military
- Space

FEATURES:

- Lowest center of gravity
- Excellent thermal coefficient of expansion compliance with board
- Can be screened similar to MIL-PRF-49470
- Available in most chip sizes



CERAMIC TYPE:

- NPO, NPQ, N2T, BX or X7R

TOP VIEW — END VIEW — SIDE VIEW

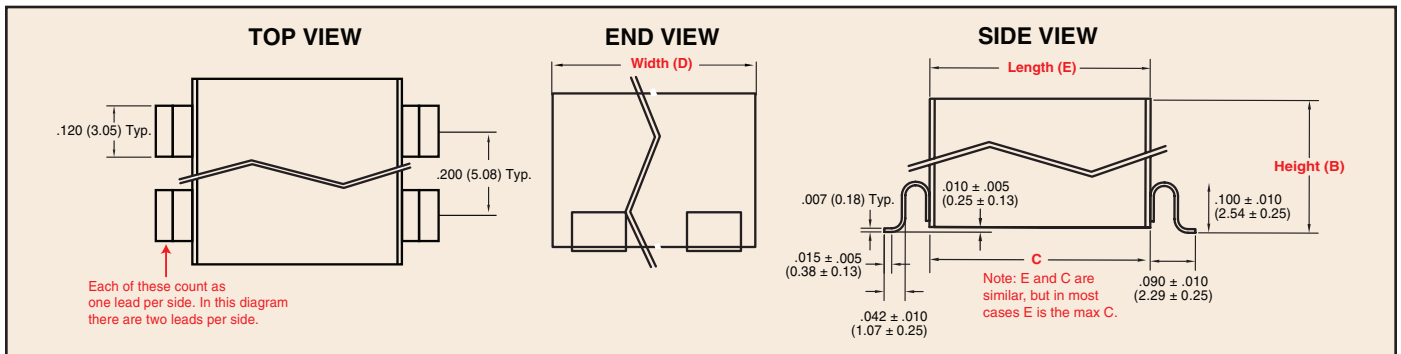

LOW STANDOFF COMPARISON

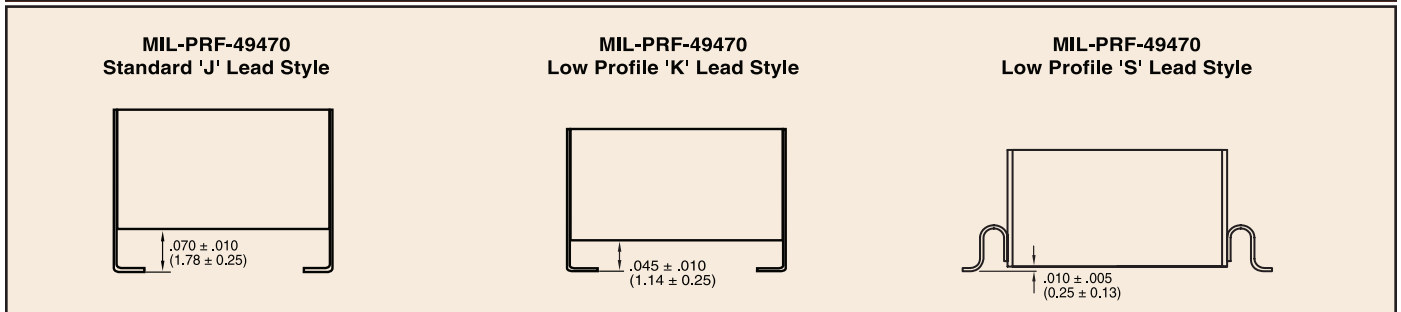

HOW TO ORDER OUR LOW PROFILE 'S' LEAD CAPACITORS

HR	S	3	01	X7R	605	K	2	S	1
Optional Screening Code	Configuration	No. of Chips	Case Code	Dielectric Type	Capacitance Code	Capacitance Tolerance *	Voltage Code	Lead Frame Style	No. of Leads
Leave Blank for Commercial HR SR (See pg. 7)	Stacked Capacitor Assembly	Number of Chips per Stack	Available in Many Sizes	X7R BX BR BQ NPO NPQ	Capacitance (in picofarads): Two significant figures followed by the number of zeros. Examples: 103=10,000 pF=.01 μF 605=6,000,000 pF=6 μF	J = ± 5% K = ± 10% M = ± 20% Z = -20% / +80%	1 = 25V 2 = 50V 3 = 100V 4 = 200V 6 = 500V	'S' Leads	Number of Leads per Side

NOTE: Other sizes, capacitances, lead frames, dielectrics (BP, BX, BR, BQ), and voltage ratings are available. Consult factory.

* Unless otherwise specified. Customer SCD takes precedence.



7169 Construction Court, San Diego, CA 92121 USA • Tel: +1-858-578-9390 • Fax: +1-858-578-6225

www.presidiocomponents.com • info@presidiocomponents.com

LOW PROFILE 'S' LEAD CAPACITORS MAXIMUM CAPACITANCE

MIL-PRF-49470 STYLE CASE SIZES								
49470 Case Size	Style 5		Style 4		Style 3		Height B inches (mm)	No. of Chips per Stack
Presidio Case Size	01		05		13			
Dielectric	BX/BR/BQ (μF)	BP (μF)	BX/BR/BQ (μF)	BP (μF)	BX/BR/BQ (μF)	BP (μF)		
50V (BX, BP)	1.2	.056	3.0	.12	10	.39	.135 (3.43)	1
	2.2	.10	6.0	.27	18	.82	.255 (6.48)	2
	3.3	.15	8.2	.33	33	1.2	.375 (9.53)	3
	—	—	12	.47	39	1.8	.495 (12.57)	4
	—	—	15	.56	47	2.2	.665 (16.89)	5
100V (BX, BP)	0.68	.039	1.5	.10	5.6	.3	.135 (3.43)	1
	1.2	.082	2.7	.22	12	.68	.255 (6.48)	2
	1.8	.12	4.7	.27	18	1.0	.375 (9.53)	3
	—	—	6.8	.39	22	1.5	.495 (12.57)	4
	—	—	8.2	.56	27	1.8	.665 (16.89)	5
200V (BR, BP)	0.27	.022	0.68	.068	2.7	.18	.135 (3.43)	1
	0.56	.039	1.5	.10	5.6	.39	.255 (6.48)	2
	0.82	.056	2.2	.15	8.2	.56	.375 (9.53)	3
	—	—	3.3	.22	10	.68	.495 (12.57)	4
	—	—	3.9	.27	12	1.0	.665 (16.89)	5
500V (BQ, BP)	0.15	.010	.39	.022	1.0	.082	.135 (3.43)	1
	0.27	.018	.68	.039	2.2	.18	.255 (6.48)	2
	0.47	.027	1.2	.068	3.9	.27	.375 (9.53)	3
	—	—	1.5	.10	4.7	.33	.495 (12.57)	4
	—	—	1.8	.12	5.6	.39	.665 (16.89)	5
C ± .025 in. (± .64 mm)	.250 (6.35)		.400 (10.16)		.450 (11.43)		Height dimensions based on commonly ordered parts. Optimized heights available.	
D Max. in. (mm)	.275 (6.99)		.425 (10.80)		1.075 (27.31)			
E Max. in. (mm)	.300 (7.62)		.440 (11.18)		.500 (12.70)			
# of 'S' Leads per Side	1		2		5			

PRESIDIO CASE SIZES — X7R AND NPO DIELECTRIC								
Presidio Case Size	01		05		13		Height inches (mm)	No. of Chips per Stack
Chip Size	2627		3941		4399			
Dielectric	X7R (μF)	NPO (μF)	X7R (μF)	NPO (μF)	X7R (μF)	NPO (μF)		
25V (Voltage Code = 1)	2.5	0.065	7.0	0.16	20.0	0.5	.110 (2.79)	1
	5.0	0.13	14.0	0.32	40.0	1.0	.160 (4.06)	2
	7.5	0.19	21.0	0.48	60.0	1.5	.235 (5.97)	3
	10.0	0.26	28.0	0.64	80.0	2.0	.310 (7.87)	4
	—	—	35.0	0.80	100.0	2.5	.385 (9.78)	5
	—	—	42.0	0.96	120.0	3.0	.460 (11.68)	6
50V (Voltage Code = 2)	2.1	0.055	5.6	0.14	18.0	0.4	.110 (2.79)	1
	4.2	0.11	11.0	0.28	36.0	0.8	.180 (4.57)	2
	6.3	0.16	17.0	0.42	54.0	1.2	.270 (6.86)	3
	8.4	0.22	22.0	0.56	72.0	1.6	.360 (9.14)	4
	—	—	28.0	0.70	90.0	2.0	.450 (11.43)	5
	—	—	33.0	0.84	110.0	2.4	.540 (13.72)	6
100V (Voltage Code = 3)	1.4	0.04	4.0	0.1	12.0	0.3	.120 (3.05)	1
	2.8	0.08	8.0	0.2	24.0	0.6	.240 (6.10)	2
	4.2	0.12	12.0	0.3	36.0	0.9	.360 (9.14)	3
	—	—	16.0	0.4	48.0	1.2	.480 (12.19)	4
	—	—	20.0	0.5	60.0	1.5	.600 (15.24)	5
	—	—	—	—	72.0	1.8	.720 (18.29)	6
200V (Voltage Code = 4)	0.42	0.022	1.2	0.056	3.5	0.18	.120 (3.05)	1
	0.84	0.044	2.4	0.11	7.0	0.36	.240 (6.10)	2
	1.20	0.066	3.6	0.17	10.0	0.54	.360 (9.14)	3
	—	—	4.8	0.22	14.0	0.72	.480 (12.19)	4
	—	—	6.0	0.28	17.0	0.90	.600 (15.24)	5
	—	—	—	—	21.0	1.10	.720 (18.29)	6
500V (Voltage Code = 6)	0.19	0.011	0.55	0.028	1.6	0.08	.120 (3.05)	1
	0.38	0.022	1.10	0.056	3.2	0.16	.240 (6.10)	2
	0.57	0.033	1.60	0.084	4.8	0.24	.360 (9.14)	3
	—	—	2.20	0.110	6.4	0.32	.480 (12.19)	4
	—	—	2.70	0.140	8.0	0.40	.600 (15.24)	5
	—	—	—	—	9.6	0.48	.720 (18.29)	6
C ±.025 in. (± .64 mm)	.275 (6.99)		.400 (10.16)		.450 (11.43)		Height dimensions based on commonly ordered parts. Optimized heights available.	
D Max. in. (mm)	.275 (6.99)		.425 (10.80)		1.075 (27.31)			
E Max. in. (mm)	.300 (7.62)		.440 (11.18)		.500 (12.70)			
# of 'S' Leads per Side	1		2		5			

Notes: 1. 75V parts are also available. Capacitance values of 75V parts are half-way between 50V and 100V.
2. Other sizes, capacitances, lead frames, dielectrics (BP, BX, BR, BQ), and voltage ratings are available. Consult factory.



INTERDIGITATED STACKED CAPACITORS FOR HIGHER FREQUENCY SWITCH MODE POWER SUPPLIES

APPLICATIONS:

- Output filtering in Switch Mode Power Supplies (SMPS)
- Applications that require higher self-resonant frequency than conventional SMPS capacitors
- Gives less noise on power supply output

FEATURES:

- Lower inductance (ESL)
- Higher self-resonant frequency
- Opposite polarity on each lead gives opposing magnetic fields, resulting in lower ESL while the capacitor is charging
- High capacitance
- Meets standard SMPS capacitor specifications

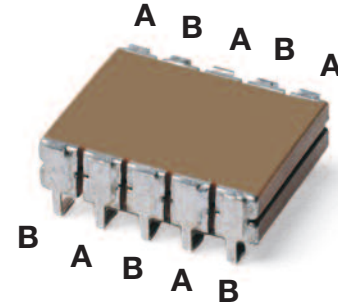

Interdigitated configuration results in reduced ESL

CERAMIC TYPE:

- X7R high K dielectric
- Temperature coefficient: $\pm 15\%$ maximum, -55°C to $+125^{\circ}\text{C}$

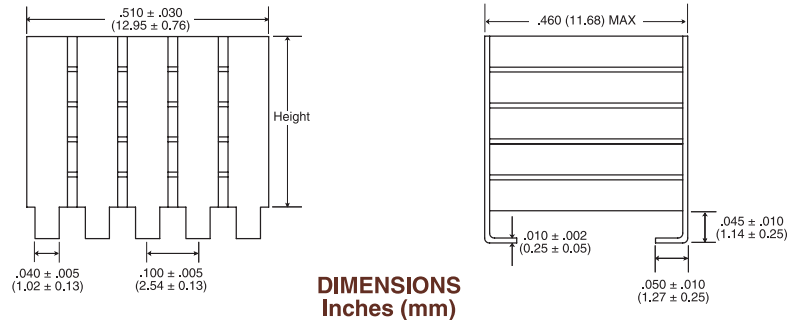
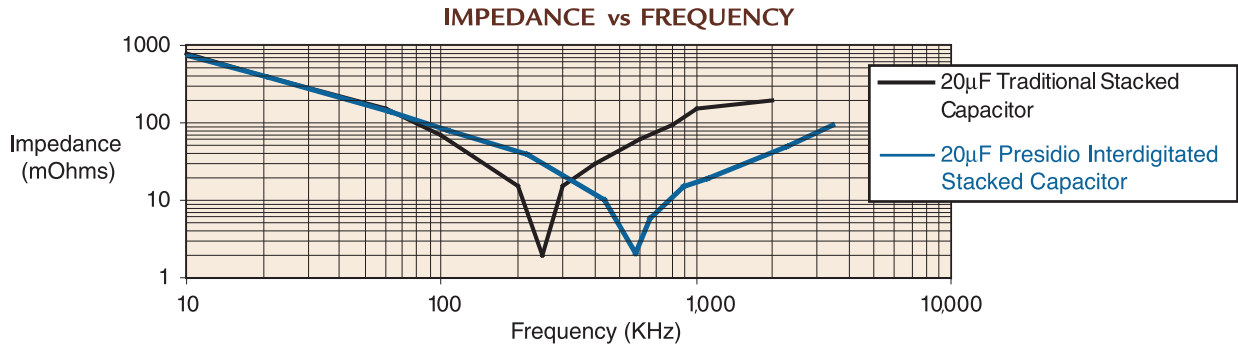

POPULAR PART NUMBERS				
Height inches (mm)	50 Volt		25 Volt	
.200 (5.08)	10 μF	HRSI214X7R106M2J5	15 μF	HRSI214X7R156M1J5
.300 (7.62)	15 μF	HRSI314X7R156M2J5	22 μF	HRSI314X7R226M1J5
.400 (10.16)	20 μF	HRSI414X7R206M2J5	30 μF	HRSI414X7R306M1J5
.500 (12.70)	25 μF	HRSI514X7R256M2J5	39 μF	HRSI514X7R396M1J5

Note: Other sizes, capacitances, lead frames, dielectrics (BP, BX, BR, BQ), and voltage ratings are available. Consult factory.



PRESIDIO PRODUCT LINES

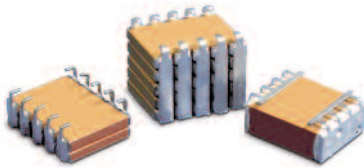

STACKS WITH INTERDIGITATED LEADS

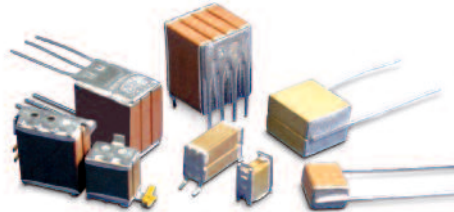

OPTIMIZED STACKED ASSEMBLY



HIGH FREQUENCY HIGH POWER STACKS

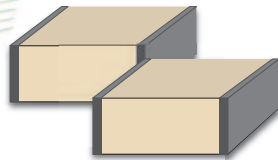

HIGH Q NPO RF CAPACITORS

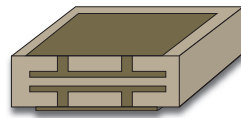

SMALLEST & BEST IN CLASS WIREBONDABLE SINGLE LAYER

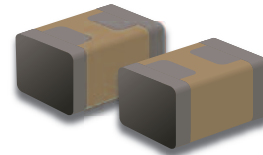

SMD BROADBAND DC BLOCK BB SERIES

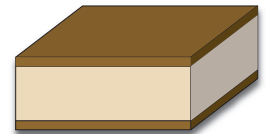

WIREBONDABLE BYPASS (VL Series) BROADBAND BYPASS (VB Series)

PRESIDIO COMPONENTS, INC. maintains more than 100 million commercial and military parts in inventory. We also offer multitudes of intermediate sizes, voltages, tolerances, termination finishes, lead-frame styles and more.

Some of our specialties include ceramic capacitors for high temperatures, cryogenic temperatures, pulse discharge applications as well as high Q dielectric, negative and positive temperature characteristic and piezoelectric ceramic formulations.

Backed with numerous patents and hundred of years of combined experience, Presidio is well suited to offer a solution to your demanding applications. Please contact our engineering team to discuss your specific needs.

100% U.S. Made, 100% U.S. Owned



'S' LEAD STACKS

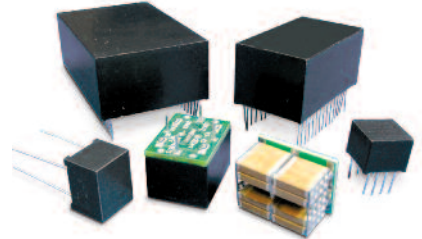

ENCAPSULATED STACKS

MAIN PRODUCT CATALOGS

Click Catalog Cover or Scan QR Code to Visit Product Page on Website



SURFACE MOUNT CERAMIC CHIP CAPACITORS



HIGH RELIABILITY EXTENDED RANGE CHIPS FOR SPACE



CERAMIC STACKED CAPACITORS FOR SMPS



HIGH TEMPERATURE CERAMIC CAPACITORS



HIGH VOLTAGE RADIAL LEADED & MIL-PRF-49467 CERAMIC CAPACITORS

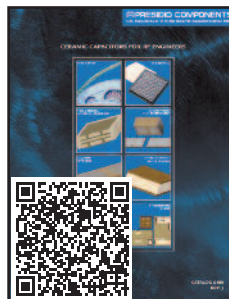

CERAMIC CAPACITORS FOR RF ENGINEERS

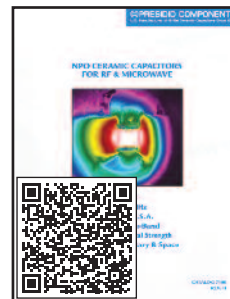

HIGH Q NPO CERAMIC CAPACITORS FOR RF & MICROWAVE



PULSE DISCHARGE CERAMIC CAPACITORS



PRESIDIO COMPONENTS, INC.

7169 Construction Court, San Diego, CA 92121 • Tel: +1-858-578-9390 • Fax: +1-858-578-6225
www.presidiocomponents.com • info@presidiocomponents.com

CERAMIC STACKED CAPACITORS FOR SWITCH MODE POWER SUPPLIES

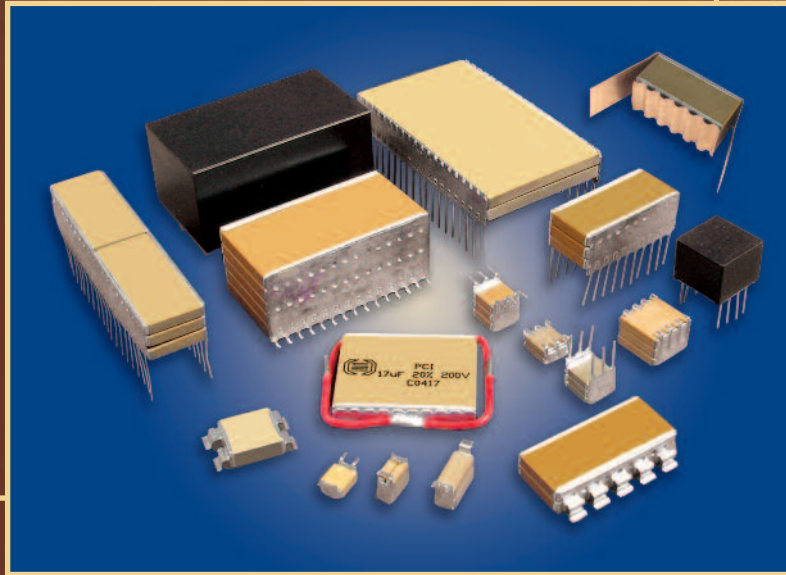

CATALOG 1001

HIGH-REL INDUSTRIAL

HIGH-REL MILITARY

HIGH-REL SPACE

HIGH VOLTAGE

Information in
this document is
subject to change
without notice.

 **PRESIDIO COMPONENTS, INC.**

CATALOG 1001
REV. H
AUGUST 2022

7169 Construction Court, San Diego, CA 92121 • Tel: +1-858-578-9390 • Fax: +1-858-578-6225
www.presidiocomponents.com • info@presidiocomponents.com