

SURFACE MOUNT BURIED BROADBAND CAPACITORS

For DC Blocking up to 100 GHz

PRESIDIO ADVANTAGE

KEY FEATURES

- ◆ -0.2 dB insertion loss at 10 GHz (OC192)
- ◆ Resonant free at critical 1.6 to 1.8 GHz
- ◆ $\pm 15\%$ capacitance change over temperature (X7R dielectric)
- ◆ Patented integration of high and low frequency capacitors
- ◆ Free equivalent circuit capacitor model for easy design
- ◆ Sizes 0805, 0603, 0502, 0402, 0302, and 0201
- ◆ Rugged monolithic body for easy pick and place

KEY APPLICATIONS

- ◆ Broadband DC Blocking Up to 100 GHz
- ◆ OC192, OC768 Transponders and Transceivers
- ◆ Broadband Microwave
- ◆ Broadband Test Equipment

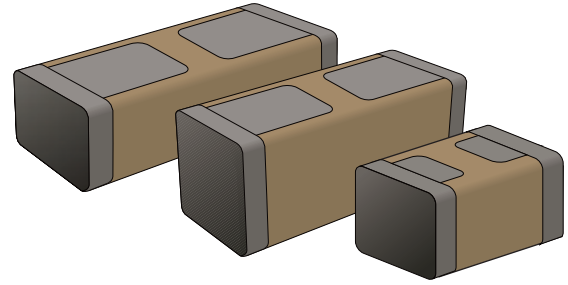

Single Layer Capacitor: GHz Range

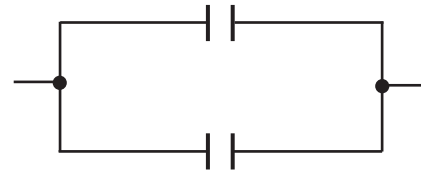

Multilayer Capacitor: kHz-MHz Range

EYE DIAGRAM COMPARISON

Presidio Components, Inc.
MBB0502X104MGP DC Block

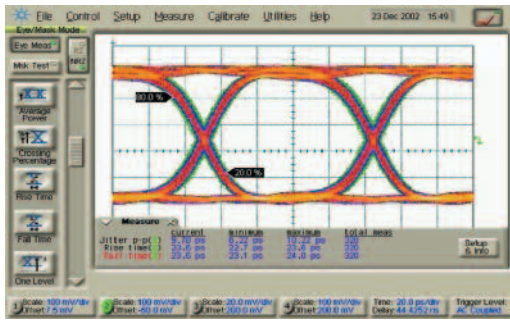

Generic MLC
0402 X7R100nF DC Block

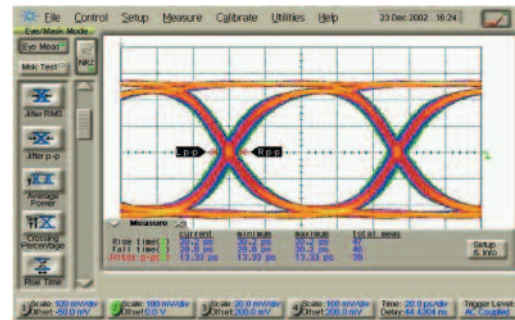

Test Setup

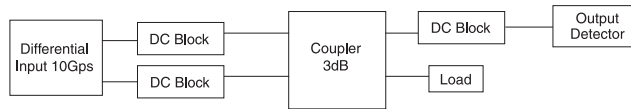

Courtesy of Phyworks

FREE MODEL DOWNLOAD

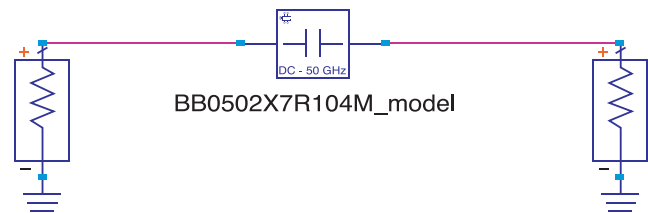
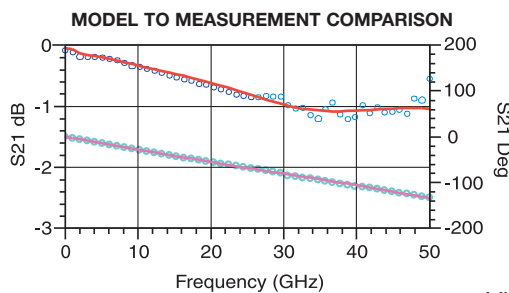

<http://www.presidiocomponents.com/BB/BB-models.html>

PRESIDIO COMPONENTS, INC.

7169 Construction Court, San Diego, CA 92121 • Tel: 858-578-9390 • Fax: 858-578-6225
www.presidiocomponents.com • info@presidiocomponents.com

SELECTED PERFORMANCE DATA

Disclaimer: The results are only valid as per described test set up. Other configurations will lead to different results.

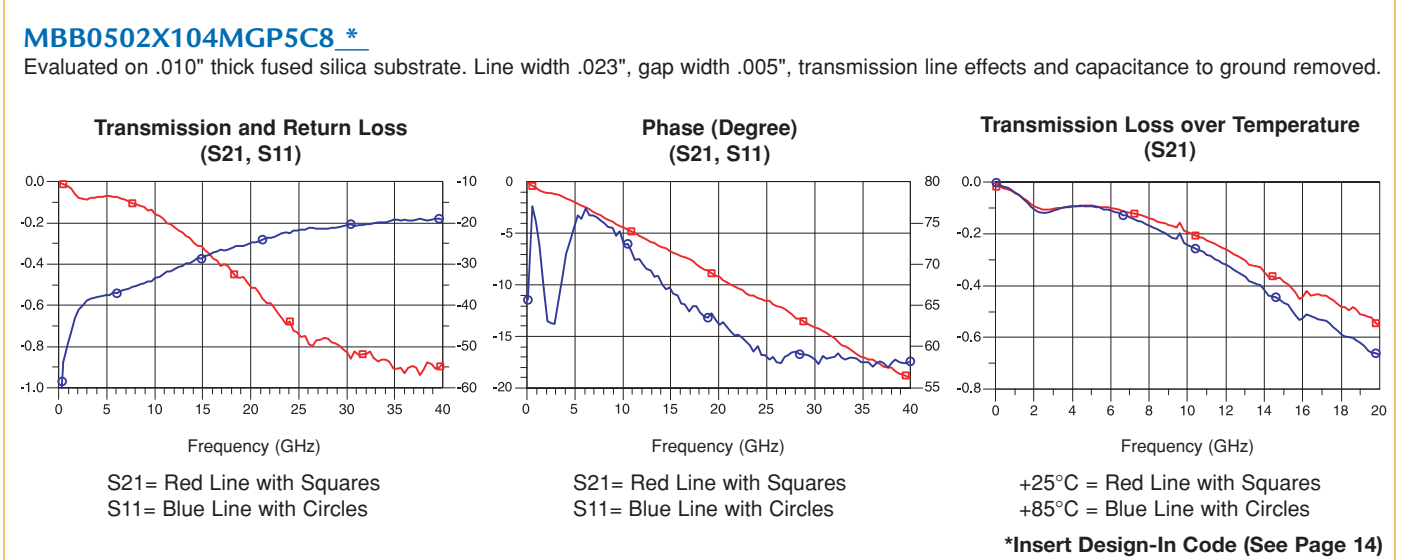
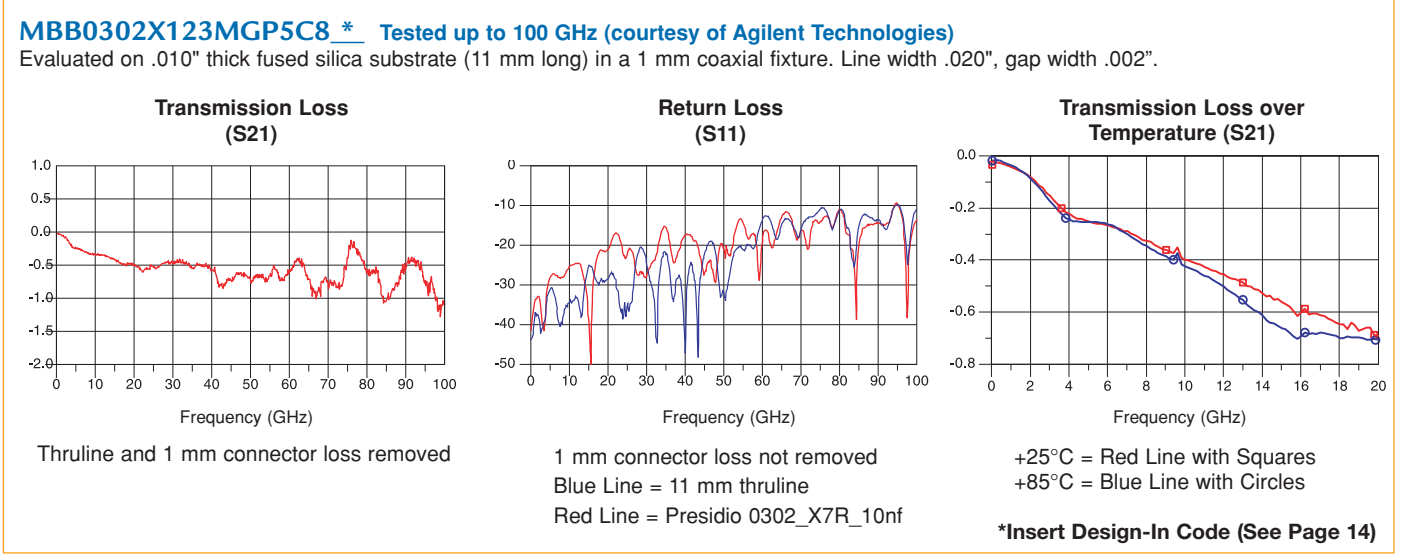
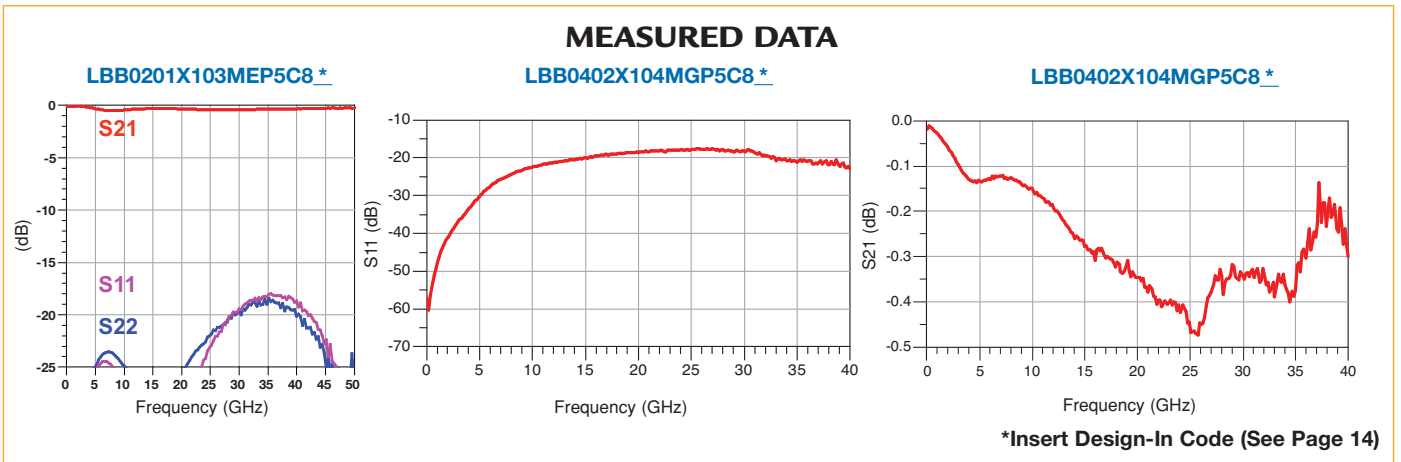

GLOBAL PART NUMBER EXAMPLE (How to Order)

M	BB	0502	X	104	M	G	P	5	C	8	*
Test Code	Product Code	Size (Pg. 13)	Dielectric	Capacitance	Capacitance Tolerance	Voltage	Termination	Packaging	RoHS Compliant	Special Code 2nd Cap Value	Design-In Code (See Page 14)

Test Codes, Dielectric Codes and Specifications

					FIT* 65° C	FIT* 85° C	FIT* 100° C	MIL-PRF-38534E Table C-III	-55681 Similar	-123 Similar	Cust. Spec.	
					L	M	N	H	K	C	S	D
					Upgradable to Codes:			H	H, K, C	H, K, C, S		
ELECTRICAL SPECIFICATIONS	NPO Dielectric Code N	X7R Dielectric Code X	Y5V Dielectric Code Y	Test Method MIL-STD-	Test Samples			Test Samples		Test Samples		
Temperature Coefficient Limit	0 ± 30 ppm/ °C	± 20%	+22%, -82%	Presidio Specification								
Temperature Coefficient Limit Cycle	-55° to +125° C	-55° to +125° C	-30° to +85° C	Presidio Specification								
Capacitance	1 MHz, 1 V AC RMS	1 kHz, 1 V AC RMS	1 kHz, 1 V AC RMS	202 Method 305	100%	100%	100%	100%	100%	100%	100%	
Dissipation Factor, maximum	0.15% max.	5% max.	19% max.	Presidio Specification	100%	100%	100%	100%	100%	100%	100%	
Insulation Resistance @ +25° C at WVDC	100,000 MΩ min.	1000 MΩ - μF	50 MΩ - μF	202 Method 302	1% AQL	1% AQL	1% AQL	100%	100%	100%	100%	
Insulation Resistance @ +125° C at WVDC	10,000 MΩ min.	100 MΩ - μF	Not Applicable	202 Method 302						1% AQL	100%	
Dielectric Withstanding Voltage (DWV)	250% of WVDC	250% of WVDC	250% of WVDC	202 Method 301	1% AQL	1% AQL	1% AQL	100%	100%	100%	100%	
Aging Effects	None	2.5% typ./decade hr.	5% typ./decade hr.	Presidio Specification								
VISUAL & MECHANICAL SPECIFICATIONS												
Visual Inspection, Workmanship				Presidio Specification	100%	100%	100%	100%	100%	100%	100%	
Solderability (solderable terminations only)				202 Method 208	13	13	13	13	13	13	13	
Bond Strength (gold termination only)	3 grams, 0.001" dia. Au wire	3 grams, 0.001" dia. Au wire	3 grams, 0.001" dia. Au wire	883 Method 2011				10	10	10	10	
Shear Strength (gold termination only)				883 Method 2019						10	10	
Physical Dimensions	See Page 13	See Page 13	See Page 13	Presidio Specification						20	20	
ENVIRONMENTAL TESTS, LEVEL 1												
Voltage Conditioning	100 hours	100 hours	100 hours	202 Method 108					10	100%	N/A	
Constant Acceleration	3,000g's, Y1 direction	3,000g's, Y1 direction	3,000g's, Y1 direction	883 Method 2001					10			
ENVIRONMENTAL TESTS, LEVEL II (SPACE)												
Thermal Shock & Voltage Conditioning	20 cycles/168 hr. min.	20 cycles/168 hr. min.	Not Applicable	202 Methods 107 & 108							100%	
Destructive Physical Analysis Report			Not Applicable	EIA-469 & MIL-PRF-123							Included	
Temperature Coefficient Limits, 0 Volt	± 30 ppm/°C	± 20%	Not Applicable	Presidio Specification							12	
Life Test	1000 hrs. each lot	1000 hrs. each lot	Not Applicable	202 Method 108							25 min.	
Humidity, Steady State, Low Voltage	240 hrs. min.	240 hrs. min.	Not Applicable	202 Method 103, A							12	
RoHS Compliant, Yes or No	Specify	Specify	Not Applicable									

*FIT (Failure In Time) Calculations are based on assumed CONTINUOUS operating temperatures 65° C, 85° C and 100° C

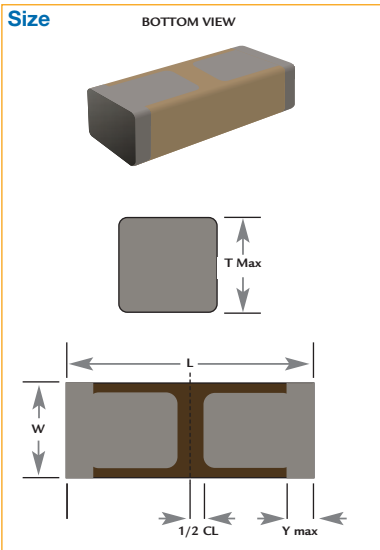

Capacitance Codes for Multilayer Capacitor

First Two Digits = Significant figures of capacitance in picofarads
Third Digit = Additional number of zeros
Example: 100 = 10 pF
 102 = 1,000 pF
 104 = 100,000 pF

Standard Capacitance Tolerance

Code	Tolerance
M	± 20%
Z	-20%, +80% for all Y5V Dielectric

Termination Codes

Code	RoHS Comp.	Typical Application	Termination Build up	Recommended Reflow Temp.
T	Yes	Solder Reflow	Palladium-Silver Nickel Barrier Plated 100% Tin	220°C to 260°C typical*
N	No	Solder Reflow	Palladium-Silver Nickel Barrier Plated 90/10 Tin Lead	220°C to 260°C typical*
P	Yes	Conductive Epoxy Non-Magnetic	Palladium-Silver	Cure Epoxy as per manufacturer's spec.
G	Yes	Conductive Epoxy, Wire Bondable	Palladium-Silver Nickel Barrier 100 μ" thick Gold typical	Cure Epoxy as per manufacturer's spec.

Working Voltage (See Page 13)

Code	WVDC	Code	WVDC
3	100	H	20
L	75	G	16
2	50	F	12
1	25	E	10

Packaging Codes

1 = Tape and Reel
 5 = Waffle Pack

RoHS

Code	Compliant
N	No
R	Legacy, ended 2012
C	Yes, started January 2013

Special Codes for Second Cap Value

Code	Nominal Capacitance
8	82 pF
2	220 pF
4	1 pF

SELECTION TABLE: BURIED BROADBAND CAPACITORS – SURFACE MOUNT

Size Code	CERAMIC BODY DIMENSIONS			Y Max. inch (mm)	1/2 CL inch (mm)	Working Voltage (WVDC)	INDUSTRIAL	INDUSTRIAL & MILITARY		SPACE	Part Numbers	Performance Curves	SZP Files	
	W inch (mm)	L inch (mm)	T Max. inch (mm)				Test Code L	Test Code M	Test Code N					
							X7R (pF)	NPO (pF)	X7R (pF)	Y5V (pF)	X7R (pF)			
0201	0.012 (0.305) ± 0.002 (0.051)	0.025 (0.635) ± 0.004 (0.102)	0.018 (0.457)	0.008 (0.203)	0.0015 (0.038) ± 0.0005 (0.013)	10	10,000+82					LBB0201X103ME ** C8 *	PDE	
0302	0.020 (0.508) ± 0.002 (0.051)	0.031 (0.787) ± 0.004 (0.102)	0.020 (0.508)	0.008 (0.203)	0.00425 (0.108) ± 0.0015 (0.038)	50			3,900+82			MBB0302X392M2 ** C8 *		
						20	12,000+82			LBB0302X123MH ** C8 *				
						16		10,000+82		MBB0302X103MG ** C8 *				
						16		12,000+82		MBB0302X123MG ** C8 *	PDE	WEB		
0402	0.023 (0.584) ± 0.003 (0.076)	0.045 (1.143) ± 0.004 (0.102)	0.032 (0.813)	0.008 (0.203)	0.0025 (0.064) ± 0.0010 (0.025)	16	100,000+82					LBB0402X104MG ** C8 *	PDE	
						16		100,000+82		MBB0402X104MG ** C8 *				
						16			10,000+82	NBB0402X103MG ** N8 *				
						75	20,000+82			LBB0402X203ML ** C8 *				
0502	0.024 (0.610) ± 0.004 (0.102)	0.052 (1.321) ± 0.006 (0.152)	0.038 (0.965)	0.010 (0.254)	0.0050 (0.127) ± 0.0030 (0.076)	100			8,200+82			MBB0502X822M3 ** C8 *		
						75			10,000+82	MBB0502X103ML ** C8 *				
						50			27,000+82	MBB0502X273M2 ** C8 *				
						20	68,000+82			LBB0502X683MH ** C8 *				
						20	100,000+82			LBB0502X104MH ** C8 *				
						16			12,000+82	MBB0502X123MG ** C8 *	PDE			
						16			68,000+82	MBB0502X683MG ** C8 *				
						16			100,000+82	MBB0502X104MG ** C8 *	PDE	WEB		
						16	820+1			MBB0502N821MG ** C4 *	PDE			
						16			220,000+82	MBB0502Y224ZG ** C8 *				
12						10,000+82	NBB0502X103MF ** N8 *							
0603	0.032 (0.813) ± 0.006 (0.152)	0.070 (1.78) ± 0.006 (0.152)	0.038 (0.965)	0.015 (0.381)	0.006 (0.152) ± 0.004 (0.102)	50			4,000+220			MBB0603X402M2 ** C2 *		
						16		150,000+220		MBB0603X154MG ** C2 *	PDE	WEB		
0805	0.050 (1.27) ± 0.010 (0.254)	0.080 (2.032) ± 0.010 (0.254)	0.038 (0.965)	0.020 (0.508)	0.006 (0.152) ± 0.004 (0.102)	75			56,000+220			MBB0805X563ML ** C2 *		
						16		150,000+220		MBB0805X154MG ** C2 *				
0805	0.050 (1.27) ± 0.010 (0.254)	0.080 (2.032) ± 0.010 (0.254)	0.038 (0.965)	0.020 (0.508)	0.004 (0.102) ± 0.004 (0.102)	50			4,000+220			MBB0805X402M2 ** C2 *		

RECOMMENDED MOUNTING METHODS

* Insert codes for termination and packaging (Page 12), and design-in location (Page 14)

PC Board Observations

- (a) Soft boards are typically used at microwave frequencies. For lowest reflection loss fused silica substrates are recommended at millimeterwave frequencies.
- (b) Microstrip line width should match or come close to capacitor width to optimize capacitor performance. Fanning out the microstrip line to match the capacitor width may degrade capacitor loss at millimeterwave frequencies.

Microstrip Line Gap

- Option 1: 0.015" to 0.010" (.381 mm to .254 mm) microstrip line gap for broadband performance at frequencies to 40 GHz.
- Option 2: 0.005" to 0.002" (0.127 mm to 0.051 mm) microstrip line gap for applications above 40 GHz.

Mounting Pad Dimensions (general recommendation*)

Case Size	INCHES			MILLIMETERS		
	A min	B min	C min*	A min	B min	C min*
0201						
0302	0.020	0.015	0.003	0.508	0.381	0.076
0402						
0502	0.023	0.025	0.010	0.584	0.635	0.254
0603	0.035	0.035	0.015	0.889	0.889	0.381
0805	0.060	0.040	0.020	1.524	1.016	0.508

Centerline of the capacitor should be located in the center of the gap in the microstrip line. Consult factory for application specific recommendations.

*Disclaimer: Gap dimension, substrate material and microstrip line width impact circuit performance.

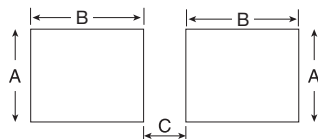

Recommended Attachment to Substrate

- (a) Solder Attach (wave reflow, vapor phase or convection tunnel oven).
 - Typical temperature ramp guidelines for solder attachment:**
 - Reflow:** Preheating — 2°C/second up to 100 seconds
Soldering — 220°C to 260°C for 20 to 60 seconds
 - Gradual Cooling:** Exit less than 100°C
- (b) Conductive Epoxy
 - It is recommended that both mounting pads be bonded simultaneously and that the pre-heat, soldering or curing, and post-heat temperatures be controlled.

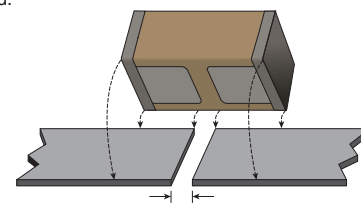

A WORD TO THE DESIGN ENGINEER

After the design work is done, outsourcing manufacturing on a global basis is a management option. At Presidio Components, we are striving for complete customer satisfaction which includes “after” service for all of our products.

We added a “Design In” locator code for quick traceability, if needed. Please select your location from the list below and add the appropriate code at the end of the part number.

If you need assistance give us a call at **(858) 578-9390** or email us at **info@presidiocomponents.com**.

UNITED STATES

USA	Code	USA	Code
Alabama	G	Nebraska	P
Alaska	P	Nevada, North	B
Arizona	D	Nevada, South	C
Arkansas	P	New Hampshire	L
California, North	B	New Jersey	J
California, South	C	New Mexico	D
Colorado	E	New York, Metro	J
Connecticut	L	New York, Upstate	K
Delaware	I	North Carolina	G
District of Columbia	H	North Dakota	O
Florida	G	Ohio	M
Georgia	G	Oklahoma	P
Hawaii	P	Oregon	A
Idaho	A	Pennsylvania	I
Illinois	N	Rhode Island	L
Indiana	M	South Carolina	G
Iowa	O	South Dakota	O
Kansas	P	Tennessee	G
Kentucky	M	Texas	F
Louisiana	P	Utah	E
Maine	L	Vermont	L
Maryland	H	Virginia	H
Massachusetts	L	Washington	A
Michigan	N	West Virginia	P
Minnesota	O	Wisconsin, East	N
Mississippi	G	Wisconsin, West	O
Missouri	N	Wyoming	E
Montana	A		

OUTSIDE THE UNITED STATES

Americas	Code	Europe	Code
Canada	R	Austria	3
Mexico	R	Belgium	1
Caribbean	R	Denmark	5
Central America	R	Finland	5
South America	R	France	2
		Germany	3
		Ireland	6
		Italy	4
		Luxembourg	1
		Netherlands	1
		Norway	5
		Sweden	5
		Switzerland	3
		United Kingdom	6
		Other European Countries	7
		Other	
		India	2
		Israel	8
		Rest of World	9

