

WIRE BONDABLE VERTICAL ELECTRODE CAPACITORS

PRESIDIO ADVANTAGE

VL SERIES

- Wire Bondable Bypass Capacitors for MMIC's

VB SERIES

- Wire Bondable Integrated Broadband Bypass Capacitors for MMIC's up to Millimeter Frequencies
- Low Profile

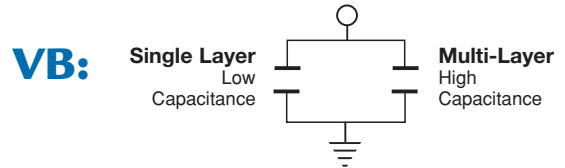
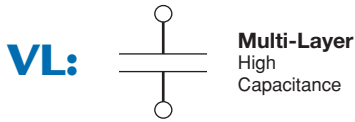
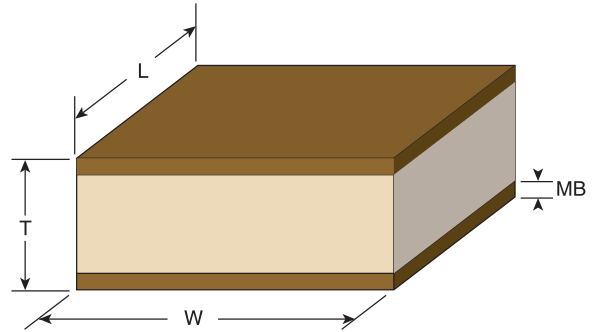

VL SERIES

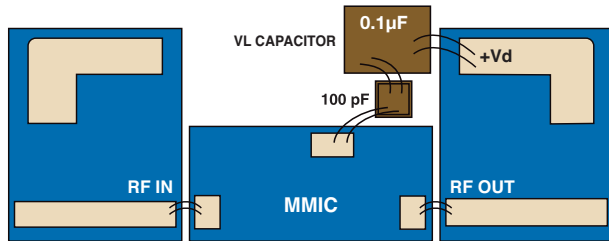

MVL4080X104MGH5C-_* (Bond Wires Included)

Data in Shunt
Average MAG S21

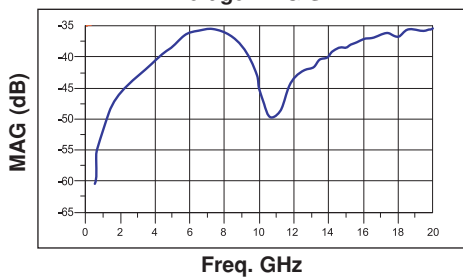

Average MAG S11

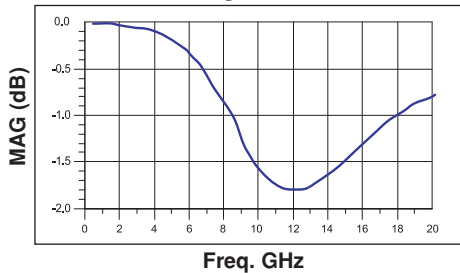

VB SERIES

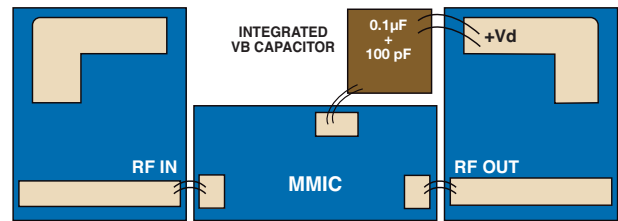

MVB4080X104ZGH5C3_* (Bond Wires Included)

Data in Shunt
Average MAG S21

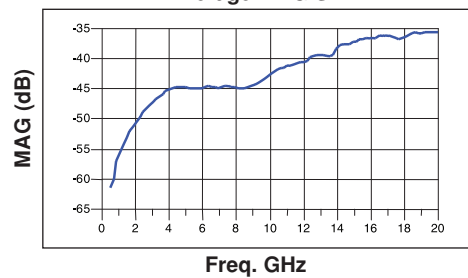

Average MAG S11

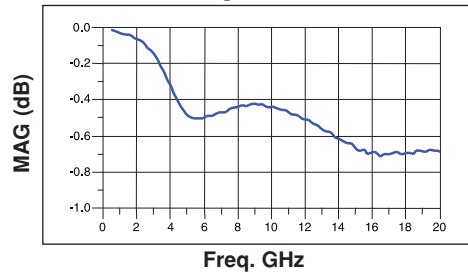

GLOBAL PART NUMBER EXAMPLE (How to Order)

M	VB	3030	X	103	M	G	H	5	C	1	*
Test Code	VB = Vertical Broadband VL = Vertical Layer	Size (Pg. 9)	Dielectric	Capacitance	Capacitance Tolerance	Voltage	Termination	Packaging	RoHS Compliant	VB – Special Code VL – Hyphen Required	Design-In Code (See Page 14)

Test Codes, Dielectric Codes and Specifications

				FIT* 85° C	FIT* 100° C	Mil-PRF-38534E Table C-III	-55681 Similar	-123 Similar	Cust. Spec.	
TEST CODES:				M	N	H	K	C	S	D
Upgradable to Codes:				H, K, C	H, K, C, S					
ELECTRICAL SPECIFICATIONS	X7R Dielectric Code X	Y5V Dielectric Code Y	Testing Method	Test Samples		Test Samples		Test Samples	Test Samples	
Temperature Coefficient Limits	± 20%	+ 22%, -82%	Presidio Specification							
Temperature Coefficient Limit Cycle	-55° to +125° C	-30° to +85° C	Presidio Specification							
Capacitance	1 kHz, 1.0 V AC RMS	1 kHz, 1.0 V AC RMS	MIL-STD-202 Meth. 305	100%	100%	100%	100%	100%	100%	
Dissipation Factor, maximum	5% max.	19% max.	Presidio Specification	100%	100%	100%	100%	100%	100%	
Insulation Resistance @ +25° C at WVDC	1000 MΩ - μF	50 MΩ - μF	MIL-STD-202 Meth. 302	1% AQL	1% AQL	100%	100%	100%	100%	
Insulation Resistance @ +125° C at WVDC	100 MΩ - μF	Not Applicable	MIL-STD-202 Meth. 302					1% AQL	100%	
Dielectric Withstanding Voltage (DWV)	250% of WVDC	250% of WVDC	MIL-STD-202 Meth. 301	1% AQL	1% AQL	100%	100%	100%	100%	
Aging Effects	2.5% typ./decade hr.	5% typ./decade hr.	Presidio Specification							
VISUAL & MECHANICAL SPECIFICATIONS										
Visual, Workmanship			Presidio Specification	100%	100%	100%	100%	100%	100%	
Bond Strength, minimum	3 grams, 0.001" dia. Au wire	3 grams, 0.001" dia. Au wire	STD-883 Method 2011			10	10	10	10	
Shear Strength, minimum	Size dependent	Size dependent	STD-883 Method 2019					10	10	
Physical Dimensions	See Page 9	See Page 9	Presidio Specification					20	20	
Metalization, minimum	100 μin (2.5 μm)	100 μin (2.5 μm)	Presidio Specification							
ENVIRONMENTAL TESTS, LEVEL I (TEST CODES K AND C)										
Voltage Conditioning	100 Hours	100 Hours	MIL-STD-202 Meth. 108, A				10	100%		
Constant Acceleration	3,000g's, Y1 Direction	3,000g's, Y1 Direction	STD-883 Method 2001				10			
ENVIRONMENTAL TESTS, LEVEL II (TEST CODE S)										
Thermal Shock & Voltage Conditioning	20 cycles/168 hr. min.	Not Applicable	MIL-STD-202 Meth. 107						100%	
Destructive Physical Analysis Report		Not Applicable	EIA-469 +MIL-PRF-123						Included	
Temperature Coeff. of Capacitance, 0 Volt	± 15%	Not Applicable	Presidio Specification						12	
Life Test	1000 Hours Each Lot	Not Applicable	MIL-STD-202 Meth. 108						25 min.	
Humidity, Steady State, Low Voltage	240 hours min.	Not Applicable	MIL-STD-202 Meth. 103, A						12	
RoHS Compliant, Yes or No	Specify	Not Applicable								

*FIT (Failure In Time) Calculations are based on assumed CONTINUOUS operating temperatures 85° C and 100° C

-3dB CUT OFF FREQUENCY	
pF	kHz
330,000	< 10
180,000	10
100,000	16
68,000	25
47,000	35
43,000	40
30,000	55
22,000	75
20,000	80
15,000	105
10,000	160
8,200	195
4,700	340

Capacitance Codes

First Two Digits = Significant figures of capacitance in picofarads
Third Digit = Additional number of zeros
Example: 100 = 10 pF
 102 = 1,000 pF
 104 = 100,000 pF

Capacitance Tolerance

Code	Tol.
M	± 20%
Z	-20%, +80% for all Y5V dielectric

Packaging

5 = Waffle Pack (standard)
 F = Grip Ring, 6.0" diameter standard

Working Voltage (See Page 9)

Code	WVDC	Code	WVDC
3	100	G	16
2	50	F	12
1	25	E	10
		C	6.3

RoHS

Code	Compliant
N	No
R	Legacy, ended 2012
C	Yes, started January 2013

Termination

VL/VB	Description
H	99.8% Au Top and Bottom Suitable for Conductive Epoxy
K	99.8% Au Top, PdAg Bottom Conductive Epoxy or Solder

100 Microns minimum thickness on both sides

Special Code

VB Series: Single Layer Capacitance Value:
 1 = 100 pF
 3 = 1800 pF
 VL Series: Hyphen Required



SELECTION TABLE: VERTICAL ELECTRODE CAPACITORS — WIRE BONDABLE

Size Code	L inch (mm)	W inch (mm)	T Max. inch (mm)	MB Max. inch (mm)	Working Voltage (WVDC) Max.	Capacitance (pF)	INDUSTRIAL & MILITARY Test Code M		SPACE Test Code N	VB SERIES		Performance Curves	S2P Files "VB"
							X7R (pF)	Y5V (pF)	X7R (pF)	PART NUMBER	VL SERIES PART NUMBER		
2020	0.020 (0.508) ± 0.003 (0.076)	0.020 (0.508) ± 0.003 (0.076)	0.015 (0.381)	0.003 (0.076)	100	Max:	390				MVL2020X391M3H5C-*		
					50	Max:	1,000				MVL2020X102M2H5C-*		
					25	Max:	2,700				MVL2020X272M1H5C-*		
					16	Max:	5,100				MVL2020X512MGH5C-*		
					10	Max:	10,000				MVL2020X103MEH5C-*		
					6.3	Max:					LVB2020X103MC *5C1*		
2040	0.020 (0.508) ± 0.003 (0.076)	0.040 (1.016) ± 0.004 (0.102)	0.017 (0.432)	0.005 (0.127)	100	Max:	1,000			MVB2040X102M3 *5C1*	MVL2040X102M3H5C-*		
					50	Max:	2,200			MVB2040X222M2 *5C1*	MVL2040X222M2H5C-*		
					25	Max:	5,100			MVB2040X512M1 *5C1*	MVL2040X512M1H5C-*		
					16	Max:	10,000			MVB2040X103MG *5C1*	MVL2040X103MGH5C-*		
					10	Max:	22,000			MVB2040X223ME *5C1*	MVL2040X223MEH5C-*		
2741	0.027 (0.686) ± 0.004 (0.102)	0.041 (1.041) ± 0.004 (0.102)	0.033 (0.838)	0.005 (0.127)	16	Max:	100,000			MVB2741X104MG *5C1*	MVL2741X104MGH5C-*		
3030	0.030 (0.762) ± 0.003 (0.076)	0.030 (0.762) ± 0.003 (0.076)	0.022 (0.559)	0.005 (0.127)	100	Max:	4,700			MVB3030X472M3 *5C1*	MVL3030X472M3H5C-*		
					50	Max:	10,000			MVB3030X103M2 *5C1*	MVL3030X103M2H5C-*		
					50	Max:		6,800			NVL3030X682M2H5N-*		
					25	Max:	15,000			MVB3030X153M1 *5C1*	MVL3030X153M1H5C-*		
					16	Max:	22,000			MVB3030X223MG *5C1*	MVL3030X223MGH5C-*		
					16	Nominal	10,000		10,000	MVB3030X103MG *5C1*	NVL3030X103MGH5N-*	PDE	WEB
					16	Max:		100,000			MVL3030Y104ZGH5C-*		
10	Max:	43,000			MVB3030X433ME *5C1*	MVL3030X433MEH5C-*							
3060	0.030 (0.762) ± 0.003 (0.076)	0.060 (1.524) ± 0.004 (0.102)	0.017 (0.432)	0.005 (0.127)	100	Max:	8,200			MVB3060X822M3 *5C1*	MVL3060X822M3H5C-*		
					50	Max:	20,000			MVB3060X203M2 *5C1*	MVL3060X203M2H5C-*		
					25	Max:	30,000			MVB3060X303M1 *5C1*	MVL3060X303M1H5C-*		
					16	Max:	47,000			MVB3060X473MG *5C1*	MVL3060X473MGH5C-*		
					10	Max:	100,000			MVB3060X104ME *5C1*	MVL3060X104MEH5C-*		
4040	0.040 (1.016) ± 0.004 (0.102)	0.040 (1.016) ± 0.004 (0.102)	0.025 (0.635)	0.005 (0.127)	100	Max:	8,200			MVB4040X822M3 *5C1*	MVL4040X822M3H5C-*		
					50	Max:	20,000			MVB4040X203M2 *5C1*	MVL4040X203M2H5C-*		
					25	Max:	30,000			MVB4040X303M1 *5C1*	MVL4040X303M1H5C-*		
					25	Max:		10,000		NVB4040X103M1 *5N1*	NVL4040X103M1H5N-*		
					16	Max:	47,000			MVB4040X473MG *5C1*	MVL4040X473MGH5C-*		
					10	Max:	100,000			MVB4040X104ME *5C1*	MVL4040X104MEH5C-*		
3080	0.030 (0.762) ± 0.003 (0.076)	0.080 (2.032) ± 0.004 (0.102)	0.025 (0.635)	0.005 (0.127)	50	Max:	15,000				MVL3080X153M2H5C-*		
					16	Max:	100,000				MVL3080X104MGH5C-*		
4080	0.042 (1.067) ± 0.004 (0.102)	0.083 (2.108) ± 0.004 (0.102)	VB 0.017 (0.432) ± VL 0.025 (0.635)	0.005 (0.127)	100	Max:	15,000			MVB4080X153M3 *5C1*	MVL4080X153M3H5C-*		
					50	Max:	30,000			MVB4080X303M2 *5C1*	MVL4080X303M2H5C-*		
					25	Max:	68,000			MVB4080X683M1 *5C1*	MVL4080X683M1H5C-*		
					16	Max:	100,000			MVB4080X104MG *5C3*	MVL4080X104MGH5C-*	PDE	WEB
5080	0.050 (1.270) ± 0.004 (0.102)	0.083 (2.108) ± 0.004 (0.102)	0.025 (0.635)	0.005 (0.127)	100	Max:	30,000			MVB5080X303M3 *5C1*	MVL5080X303M3H5C-*		
					50	Max:	68,000			MVB5080X683M2 *5C1*	MVL5080X683M2H5C-*		
					25	Max:		100,000			NVL5080X104M1H5N-*		
					16	Max:	180,000			MVB5080X184MG *5C1*	MVL5080X184MGH5C-*		
					12	Max:		100,000			NVB5080X104MF *5N3*		
					10	Max:	220,000			MVB5080X224ME *5C1*	MVL5080X224MEH5C-*		

* Insert codes for termination (Page 8)
and design-in location (Page 14)



7169 Construction Court, San Diego, CA 92121 • Tel: 858-578-9390 • Fax: 858-578-6225
www.presidiocomponents.com • info@presidiocomponents.com

A WORD TO THE DESIGN ENGINEER

After the design work is done, outsourcing manufacturing on a global basis is a management option. At Presidio Components, we are striving for complete customer satisfaction which includes “after” service for all of our products.

We added a “Design In” locator code for quick traceability, if needed. Please select your location from the list below and add the appropriate code at the end of the part number.

If you need assistance give us a call at **(858) 578-9390** or email us at **info@presidiocomponents.com**.

UNITED STATES

USA	Code	USA	Code
Alabama	G	Nebraska	P
Alaska	P	Nevada, North	B
Arizona	D	Nevada, South	C
Arkansas	P	New Hampshire	L
California, North	B	New Jersey	J
California, South	C	New Mexico	D
Colorado	E	New York, Metro	J
Connecticut	L	New York, Upstate	K
Delaware	I	North Carolina	G
District of Columbia	H	North Dakota	O
Florida	G	Ohio	M
Georgia	G	Oklahoma	P
Hawaii	P	Oregon	A
Idaho	A	Pennsylvania	I
Illinois	N	Rhode Island	L
Indiana	M	South Carolina	G
Iowa	O	South Dakota	O
Kansas	P	Tennessee	G
Kentucky	M	Texas	F
Louisiana	P	Utah	E
Maine	L	Vermont	L
Maryland	H	Virginia	H
Massachusetts	L	Washington	A
Michigan	N	West Virginia	P
Minnesota	O	Wisconsin, East	N
Mississippi	G	Wisconsin, West	O
Missouri	N	Wyoming	E
Montana	A		

OUTSIDE THE UNITED STATES

Americas	Code	Europe	Code
Canada	R	Austria	3
Mexico	R	Belgium	1
Caribbean	R	Denmark	5
Central America	R	Finland	5
South America	R	France	2
		Germany	3
		Ireland	6
		Italy	4
		Luxembourg	1
		Netherlands	1
		Norway	5
		Sweden	5
		Switzerland	3
		United Kingdom	6
		Other European Countries	7
		Other	
		India	2
		Israel	8
		Rest of World	9

