

ULTRA-PORCELAIN™ RF CAPACITORS

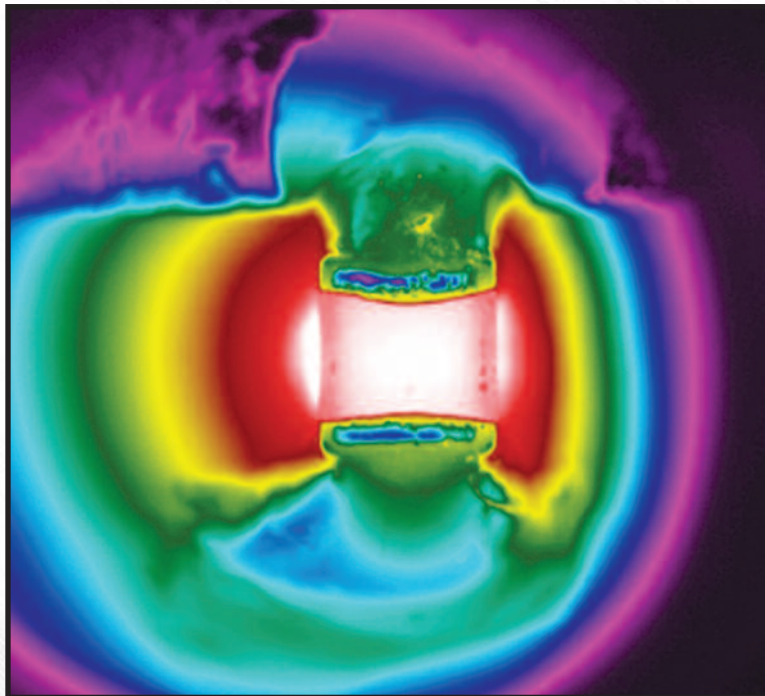

**VERY COOL PERFORMANCE
WITH RF POWER**

SURFACE MOUNT ULTRA PORCELAIN™ CAPACITORS

PRESIDIO ADVANTAGE

- Ultra Lowest ESL
- Ultra Combination of ESR and Q
- Ultra Stable Over Time — No Aging
- Amplified High Power Tuning
- High Reliability – Low Profile
- Ultra Highest Q
- Ultra Stable NPO
- Ultra Compliant — Strontium Free
- Matching Oscillator Design
- Typical Designs from DC to 6 GHz+

DIELECTRIC

Porcelain UP: Ultra temperature stable dielectric. Extremely low ESR. For RF power and high Q applications.

Porcelain P90: Dielectric increases over temperature (90ppm/C). Extremely low ESR. For temperature compensation.

Ceramic NPO: Ultra temperature stable dielectric. Low ESR. Suited for higher capacitance applications.

Ceramic BX: Temperature stable X7R dielectric. Suited for highest capacitance value applications.

HI-REL SPACE APPLICATIONS

For information on our Ultra-Porcelain™ Hi-Rel Capacitors for Space See Pages 14 and 15

TYPICAL APPLICATIONS

Filter Capacitors

A filter design requires a specific capacitance value, cF, and at the upper end of the filter response, fF, the effective capacity must not exceed cF by more than a specified amount of delta C. Once cF is determined, case size, voltage rating and temperature characteristics can be selected.

DC Block and RF Bypass

The bandwidth over which the insertion loss meets specification is determined by the location of parallel resonances. Minimum insertion loss at the band center is achieved by choosing a capacitor whose lowest series resonance is approximately at this frequency. Low impedance is typically more important than the capacitance value.

Low Noise Applications

Dissipation loss is the consideration. ESR is very small at the series resonance, very large at the parallel resonance. The neighboring parallel resonances determine the bandwidth.

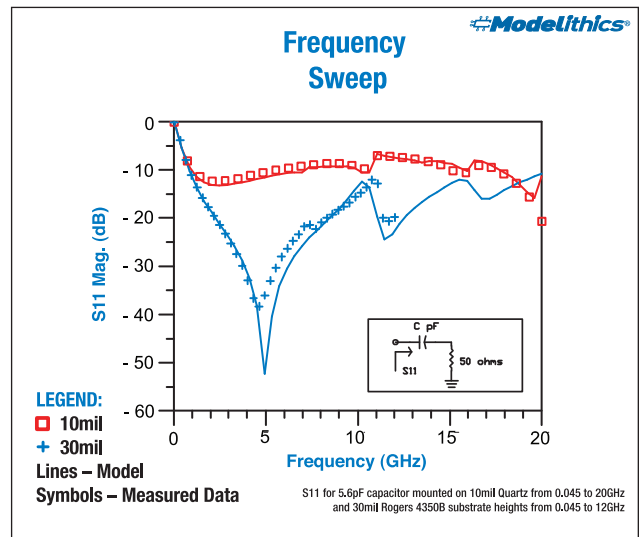

Presidio's capacitors are available in various screening levels from Commercial to Space Grade (See Pages 16 and 17).

Front Cover: Thermal image of 0505 10pF during RF Power Test



COMMERCIAL & HIGH RELIABILITY PART NUMBERS RF, MICROWAVE & POWER

Specifications

ELECTRICAL SPECIFICATIONS	UP Dielectric Code: UP	P90 Dielectric Code: P90	NPO Dielectric Code: NPO	X7R Dielectric Code: X7R	Testing Method MIL-STD-55681
Temperature Coefficient of Capacitance, 0 Volt	0 ± 30 ppm/°C	90 ± 20 ppm/°C	0 ± 30 ppm/°C	± 15%	Para 3.23
Typical Q	20,000	20,000	2,000	80 (1kHz)	
Rated Operating Temperature Range	-55° to +125° C	-55° to +125° C	-55° to +125° C	-55° to +125° C	Para 3.14
Capacitance up to 1000pF	1 MHz, 1.0 V AC RMS	1 MHz, 1.0 V AC RMS	1 MHz, 1.0 V AC RMS		Para 3.7
Capacitance >1000pF	1 kHz, 1.0 V AC RMS	1 kHz, 1.0 V AC RMS	1 kHz, 1.0 V AC RMS	1 kHz, 1.0 V AC RMS	
Dissipation Factor, max.	0.05% max.	0.05% max.	0.15% max.	2.5% max.	Para 3.8
Insulation Resistance @ +25° C at WVDC	1,000,000 MΩ min.	1,000,000 MΩ min.	100,000 MΩ min.	1,000 MΩ Farad	Para 3.9
Insulation Resistance @ +125° C at WVDC	100,000 MΩ min.	100,000 MΩ min.	10,000 MΩ min.	100 MΩ Farad	Para 3.12
Dielectric Withstanding Voltage (DWV)	250% of WVDC ≤ 300V 200% of WVDC = 500V	250% of WVDC ≤ 300V 200% of WVDC = 500V	250% of WVDC ≤ 300V 200% of WVDC = 500V	250% of WVDC ≤ 300V 200% of WVDC = 500V	
Aging Effects	None	None	None	2.5% max/decade hr	

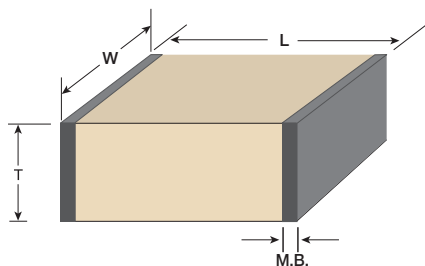

Capacitance Codes for Multilayer Capacitor

First Two Digits = Significant Figures of Capacitance in Picofarads

Third Digit = Additional Number of Zeros

Example:
100 = 10 pF
102 = 1,000 pF
104 = 100,000 pF

Capacitance Tolerance Codes

Code	Tolerance	Cap Range
A	± .05 pF	≤ 4.7 pF
B	± .1 pF	< 10 pF
C	± .25 pF	< 10 pF
D	± .5 pF	< 10 pF
F	± 1%	≥ 10 pF
G	± 2%	≥ 10 pF
J	± 5%	≥ 10 pF
K	± 10%	≥ 10 pF
M	± 20%	≥ 10 pF

Termination Codes

Code	RoHS Comp.	Typical Application	Termination Build up	Recommended Reflow Temp.
T	Yes	Solder Reflow	100% Tin Plated Nickel Barrier Silver Base	220°C to 260°C Typical*
N	No	Solder Reflow	90% Tin/10% Lead Plated Nickel Barrier Silver Base	220°C to 260°C Typical*
P	Yes	Conductive Epoxy Non-Magnetic	Palladium-Silver	Cure Epoxy as per Manufacturer's Spec.
G	Yes	Conductive Epoxy, Wire Bondable	50 μ" Gold Typical Nickel Barrier Silver Base	Cure Epoxy as per Manufacturer's Spec.

Working Voltage

Code	WVDC	Code	WVDC
2	50	9	1000
3	100	N	1500
A	150	P	2000
4	200	Q	2500
&	250	R	3000
5	300	S	3600
6	500	U	5000
#	800	+	7200

Packaging Codes

1 = Tape and Reel
5 = Waffle Pack

RoHS

Code	Compliant
N	No
R	Legacy (Ended 2012)
C	Yes (Started 1/2013)

Presidio's UP capacitors can be upscreened to SPACE LEVEL testing. Consult the factory for details. Some voltage derating may apply.

COMMERCIAL PART NUMBER EXAMPLE (How to Order)

0505	UP	101	K	2	T	1	C	A
Size	Dielectric (See Above)	Capacitance	Capacitance Tolerance	Voltage	Termination	Packaging	RoHS Compliant	Design-In Code (See Page 19)



PRESIDIO COMPONENTS, INC.

7169 Construction Court, San Diego, CA 92121 • Tel: 858-578-9390 • Fax: 858-578-6225

www.presidiocomponents.com • info@presidiocomponents.com

PRESIDIO ULTRA-PORCELAIN™ CAPACITORS

SIZE 0402

COMMERCIAL PART NUMBER	CAP. (pF)	TOL.	WVDC
0402UP0R1_4T1C-*	0.1	A B	200
0402UP0R2_4T1C-*	0.2	A B	200
0402UP0R3_4T1C-*	0.3	A B	200
0402UP0R4_4T1C-*	0.4	A B	200
0402UP0R5_4T1C-*	0.5	A B	200
0402UP0R6_4T1C-*	0.6	A B	200
0402UP0R7_4T1C-*	0.7	A B	200
0402UP0R8_4T1C-*	0.8	A B	200
0402UP0R9_4T1C-*	0.9	A B	200
0402UP1R0_4T1C-*	1.0	A B	200
0402UP1R1_4T1C-*	1.1	A B	200
0402UP1R2_4T1C-*	1.2	A B	200
0402UP1R5_4T1C-*	1.5	A B	200
0402UP1R6_4T1C-*	1.6	A B	200

COMMERCIAL PART NUMBER	CAP. (pF)	TOL.	WVDC
0402UP1R8_4T1C-*	1.8	A B	200
0402UP2R0_4T1C-*	2.0	A B	200
0402UP2R2_4T1C-*	2.2	A B	200
0402UP2R4_4T1C-*	2.4	A,B,C	200
0402UP2R7_4T1C-*	2.7	A,B,C	200
0402UP3R0_4T1C-*	3.0	A,B,C	200
0402UP3R3_4T1C-*	3.3	A,B,C	200
0402UP3R6_4T1C-*	3.6	A,B,C	200
0402UP3R9_4T1C-*	3.9	A,B,C	200
0402UP4R3_4T1C-*	4.3	A,B,C	200
0402UP4R7_4T1C-*	4.7	A,B,C	200
0402UP5R1_4T1C-*	5.1	A,B,C	200
0402UP5R6_4T1C-*	5.6	A,B,C	200
0402UP6R2_4T1C-*	6.2	A,B,C	200

COMMERCIAL PART NUMBER	CAP. (pF)	TOL.	WVDC
0402UP6R8_4T1C-*	6.8	B,C,D	200
0402UP7R5_4T1C-*	7.5	C,D,F,G,J	200
0402UP8R2_4T1C-*	8.2	C,D,F,G,J	200
0402UP9R1_4T1C-*	9.1	C,D,F,G,J	200
0402UP100_4T1C-*	10	C,D,F,G,J	200
0402UP110_4T1C-*	11	C,D,F,G,J	200
0402UP120_4T1C-*	12	C,D,F,G,J	200
0402UP150_4T1C-*	15	C,D,F,G,J	200
0402UP180_4T1C-*	18	C,D,F,G,J	200
0402UP200_4T1C-*	20	C,D,F,G,J	200
0402UP240_4T1C-*	24	C,D,F,G,J	200
0402UP270_4T1C-*	27	C,D,F,G,J	200

For special values please contact the factory.

PART NUMBER CODES AND DIMENSIONS

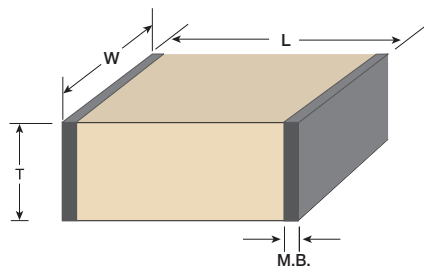

Capacitance Codes for Multilayer Capacitor

First Two Digits = Significant Figures of Capacitance in Picofarads

Third Digit = Additional Number of Zeros

Example: 100 = 10 pF
102 = 1,000 pF
104 = 100,000 pF

Capacitance Tolerance Codes

Code	Tolerance	Cap Range
A	± .05 pF	≤ 4.7 pF
B	± .1 pF	< 10 pF
C	± .25 pF	< 10 pF
D	± .5 pF	< 10 pF
F	± 1%	≥ 10 pF
G	± 2%	≥ 10 pF
J	± 5%	≥ 10 pF
K	± 10%	≥ 10 pF
M	± 20%	≥ 10 pF

LENGTH (L) INCH (mm)	WIDTH (W) INCH (mm)	THICKNESS (T) INCH (mm)	METALIZATION BAND (M.B.) INCH (mm)
0.040 ± 0.004 (1.02 ± 0.10)	0.020 ± 0.004 (0.508 ± 0.10)	0.024 MAX (0.61) MAX	0.004 (0.102) min. band 0.015 (0.381) min. space

Termination Codes

Code	RoHS Comp.	Typical Application	Termination Build up	Recommended Reflow Temp.
T	Yes	Solder Reflow	100% Tin Plated Nickel Barrier Silver Base	220°C to 260°C Typical*
N	No	Solder Reflow	90% Tin/10% Lead Plated Nickel Barrier Silver Base	220°C to 260°C Typical*
P	Yes	Conductive Epoxy Non-Magnetic	Palladium-Silver	Cure Epoxy as per Manufacturer's Spec.
G	Yes	Conductive Epoxy, Wire Bondable	50 μ" Gold Typical Nickel Barrier Silver Base	Cure Epoxy as per Manufacturer's Spec.

Working Voltage

Code	WVDC	Code	WVDC
2	50	9	1000
3	100	N	1500
A	150	P	2000
4	200	Q	2500
&	250	R	3000
5	300	S	3600
6	500	U	5000
#	800	+	7200

Packaging Codes

1 = Tape and Reel
5 = Waffle Pack

RoHS

Code	Compliant
N	No
R	Legacy (Ended 2012)
C	Yes (Started 1/2013)

Presidio's UP capacitors can be upscreened to SPACE LEVEL testing. Consult the factory for details. Some voltage derating may apply.

COMMERCIAL PART NUMBER EXAMPLE (How to Order)

0402	UP	270	J	4	T	1	C	A
Size	Dielectric (See Page 3)	Capacitance	Capacitance Tolerance	Voltage	Termination	Packaging	RoHS Compliant	Design-In Code (See Page 19)

PRESIDIO ULTRA-PORCELAIN™ CAPACITORS 0402 PERFORMANCE CHARTS

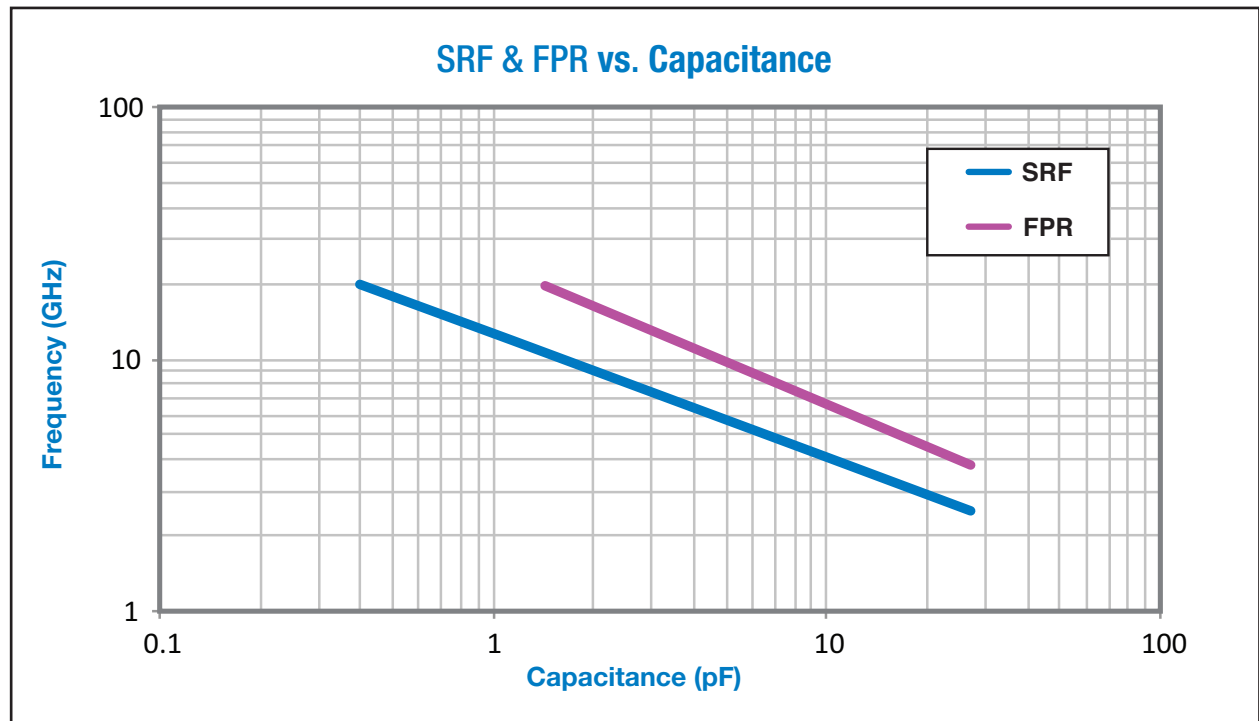
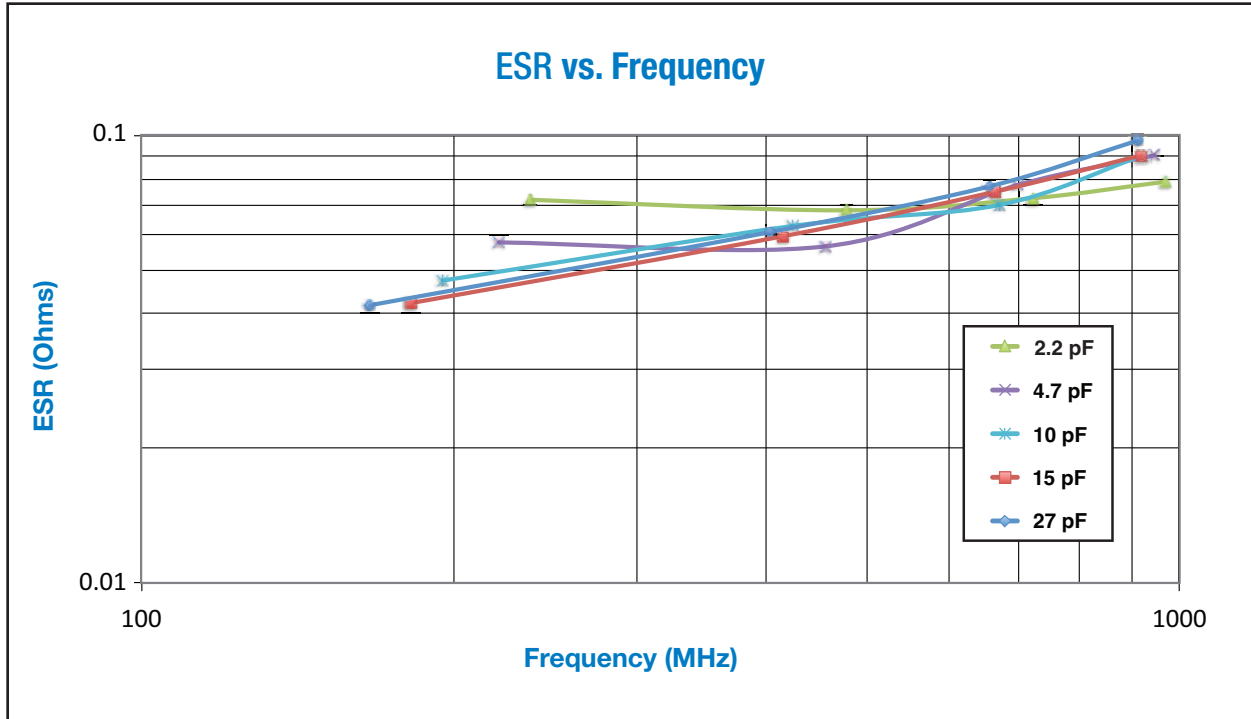

PRESIDIO ULTRA-PORCELAIN™ CAPACITORS

SIZE 0505

COMMERCIAL PART NUMBER	CAP. (pF)	TOL.	WVDC
0505UP0R1_AT1C-*	0.1	A,B	150
0505UP0R2_AT1C-*	0.2	A,B	150
0505UP0R3_AT1C-*	0.3	A,B	150
0505UP0R4_AT1C-*	0.4	A,B	150
0505UP0R5_AT1C-*	0.5	A,B	150
0505UP0R6_AT1C-*	0.6	A,B	150
0505UP0R7_AT1C-*	0.7	A,B	150
0505UP0R8_AT1C-*	0.8	A,B	150
0505UP0R9_AT1C-*	0.9	A,B	150
0505UP1R0_AT1C-*	1.0	A,B	150
0505UP1R1_AT1C-*	1.1	A,B,C	150
0505UP1R2_AT1C-*	1.2	A,B,C	150
0505UP1R5_AT1C-*	1.5	A,B,C	150
0505UP1R6_AT1C-*	1.6	A,B,C	150
0505UP1R8_AT1C-*	1.8	A,B,C	150
0505UP2R0_AT1C-*	2.0	A,B,C	150
0505UP2R2_AT1C-*	2.2	A,B,C	150
0505UP2R4_AT1C-*	2.4	A,B,C	150
0505UP2R7_AT1C-*	2.7	A,B,C	150
0505UP3R0_AT1C-*	3.0	A,B,C	150
0505UP3R3_AT1C-*	3.3	A,B,C	150
0505UP3R6_AT1C-*	3.6	A,B,C	150
0505UP3R9_AT1C-*	3.9	A,B,C	150
0505UP4R3_AT1C-*	4.3	A,B,C	150
0505UP4R7_AT1C-*	4.7	A,B,C	150
0505UP5R1_AT1C-*	5.1	A,B,C	150

COMMERCIAL PART NUMBER	CAP. (pF)	TOL.	WVDC
0505UP5R6_AT1C-*	5.6	A,B,C	150
0505UP6R2_AT1C-*	6.2	A,B,C	150
0505UP6R8_AT1C-*	6.8	A,B,C	150
0505UP7R5_AT1C-*	7.5	A,B,C	150
0505UP8R2_AT1C-*	8.2	A,B,C	150
0505UP9R1_AT1C-*	9.1	A,B,C	150
0505UP100_AT1C-*	10	F,G,J	150
0505UP110_AT1C-*	11	F,G,J	150
0505UP120_AT1C-*	12	F,G,J	150
0505UP150_AT1C-*	15	F,G,J	150
0505UP180_AT1C-*	18	F,G,J	150
0505UP200_AT1C-*	20	F,G,J,K,M	150
0505UP220_AT1C-*	22	F,G,J,K,M	150
0505UP240_AT1C-*	24	F,G,J,K,M	150
0505UP270_AT1C-*	27	F,G,J,K,M	150
0505UP300_AT1C-*	30	F,G,J,K,M	150
0505UP330_AT1C-*	33	F,G,J,K,M	150
0505UP360_AT1C-*	36	F,G,J,K,M	150
0505UP390_AT1C-*	39	F,G,J,K,M	150
0505UP430_AT1C-*	43	F,G,J,K,M	150
0505UP470_AT1C-*	47	F,G,J,K,M	150
0505UP510_AT1C-*	51	F,G,J,K,M	150
0505UP560_AT1C-*	56	F,G,J,K,M	150
0505UP620_AT1C-*	62	F,G,J,K,M	150
0505UP680_AT1C-*	68	F,G,J,K,M	150
0505UP750_AT1C-*	75	F,G,J,K,M	150

COMMERCIAL PART NUMBER	CAP. (pF)	TOL.	WVDC
0505UP820_AT1C-*	82	F,G,J,K,M	150
0505UP910_AT1C-*	91	F,G,J,K,M	150
0505UP101_AT1C-*	100	F,G,J,K,M	150
0505NPO111_AT1C-*	110	F,G,J,K,M	150
0505NPO121_AT1C-*	120	F,G,J,K,M	150
0505NPO151_AT1C-*	150	F,G,J,K,M	150
0505NPO181_AT1C-*	180	F,G,J,K,M	150
0505NPO201_AT1C-*	200	F,G,J,K,M	150
0505NPO221_AT1C-*	220	F,G,J,K,M	150
0505NPO241_AT1C-*	240	F,G,J,K,M	150
0505NPO271_AT1C-*	270	F,G,J,K,M	150
0505NPO301_AT1C-*	300	F,G,J,K,M	150
0505NPO331_AT1C-*	330	F,G,J,K,M	150
0505NPO361_AT1C-*	360	F,G,J,K,M	150
0505NPO391_AT1C-*	390	F,G,J,K,M	150
0505NPO431_AT1C-*	430	F,G,J,K,M	150
0505NPO471_AT1C-*	470	F,G,J,K,M	150
0505NPO511_AT1C-*	510	F,G,J,K,M	150
0505NPO561_AT1C-*	560	F,G,J,K,M	150
0505NPO621_AT1C-*	620	F,G,J,K,M	150
0505NPO681_2T1C-*	680	F,G,J,K,M	50
0505NPO751_2T1C-*	750	F,G,J,K,M	50
0505NPO821_2T1C-*	820	F,G,J,K,M	50
0505NPO911_2T1C-*	910	F,G,J,K,M	50
0505NPO102_2T1C-*	1000	F,G,J,K,M	50

For special values please contact the factory.

PART NUMBER CODES AND DIMENSIONS

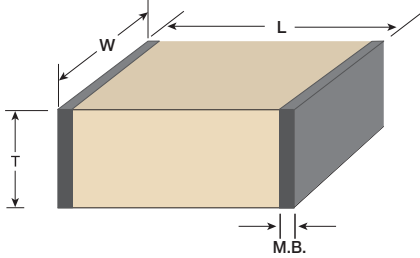

Capacitance Codes for Multilayer Capacitor

First Two Digits = Significant Figures of Capacitance in Picofarads
Third Digit = Additional Number of Zeros
Example: 100 = 10 pF
 102 = 1,000 pF
 104 = 100,000 pF

Capacitance Tolerance Codes

Code	Tolerance	Cap Range
A	± .05 pF	≤ 4.7 pF
B	± .1 pF	< 10 pF
C	± .25 pF	< 10 pF
D	± .5 pF	< 10 pF
F	± 1%	≥ 10 pF
G	± 2%	≥ 10 pF
J	± 5%	≥ 10 pF
K	± 10%	≥ 10 pF
M	± 20%	≥ 10 pF

LENGTH (L) INCH (mm)	WIDTH (W) INCH (mm)	THICKNESS (T) INCH (mm)	METALIZATION BAND (M.B.) INCH (mm)
0.055 + 0.015/ - 0.010 (1.397 + 0.381/ - 0.254)	0.055 ± 0.015 (1.397 ± 0.381)	0.057 MAX (1.448 MAX)	0.005 (0.127) min. band 0.015 (0.381) min. space

Termination Codes

Code	RoHS Comp.	Typical Application	Termination Build up	Recommended Reflow Temp.
T	Yes	Solder Reflow	100% Tin Plated Nickel Barrier Silver Base	220°C to 260°C Typical*
N	No	Solder Reflow	90% Tin/10% Lead Plated Nickel Barrier Silver Base	220°C to 260°C Typical*
P	Yes	Conductive Epoxy Non-Magnetic	Palladium-Silver	Cure Epoxy as per Manufacturer's Spec.
G	Yes	Conductive Epoxy, Wire Bondable	50 μ" Gold Typical Nickel Barrier Silver Base	Cure Epoxy as per Manufacturer's Spec.

Working Voltage

Code	WVDC	Code	WVDC
2	50	9	1000
3	100	N	1500
A	150	P	2000
4	200	Q	2500
&	250	R	3000
5	300	S	3600
6	500	U	5000
#	800	+	7200

Packaging Codes

1 = Tape and Reel
5 = Waffle Pack

RoHS

Code	Compliant
N	No
R	Legacy (Ended 2012)
C	Yes (Started 1/2013)

Presidio's UP capacitors can be upscreened to SPACE LEVEL testing. Consult the factory for details. Some voltage derating may apply.

COMMERCIAL PART NUMBER EXAMPLE (How to Order)

0505	UP	101	J	A	T	1	C	A
Size	Dielectric (See Page 3)	Capacitance	Capacitance Tolerance	Voltage	Termination	Packaging	RoHS Compliant	Design-In Code (See Page 19)

PRESIDIO ULTRA-PORCELAIN™ CAPACITORS

0505 PERFORMANCE CHARTS

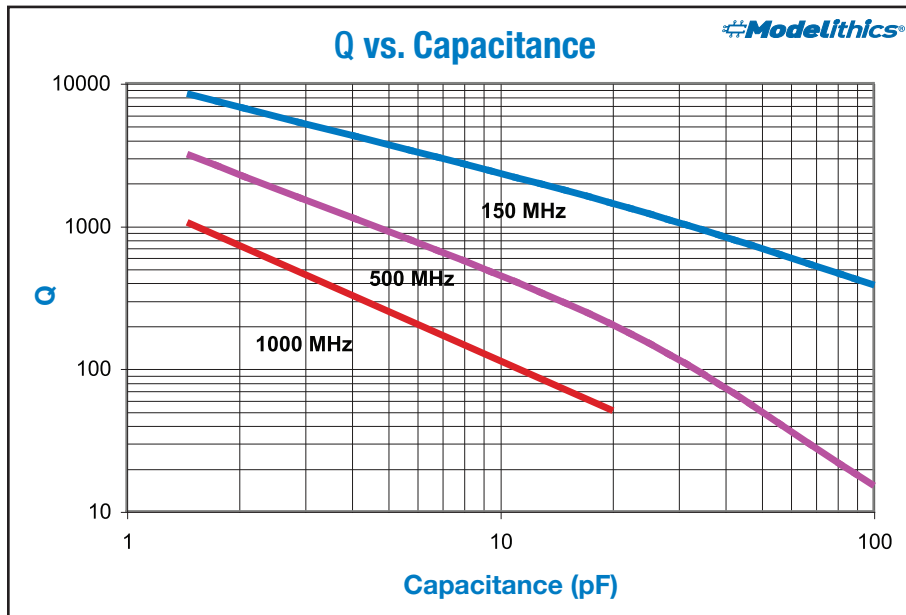
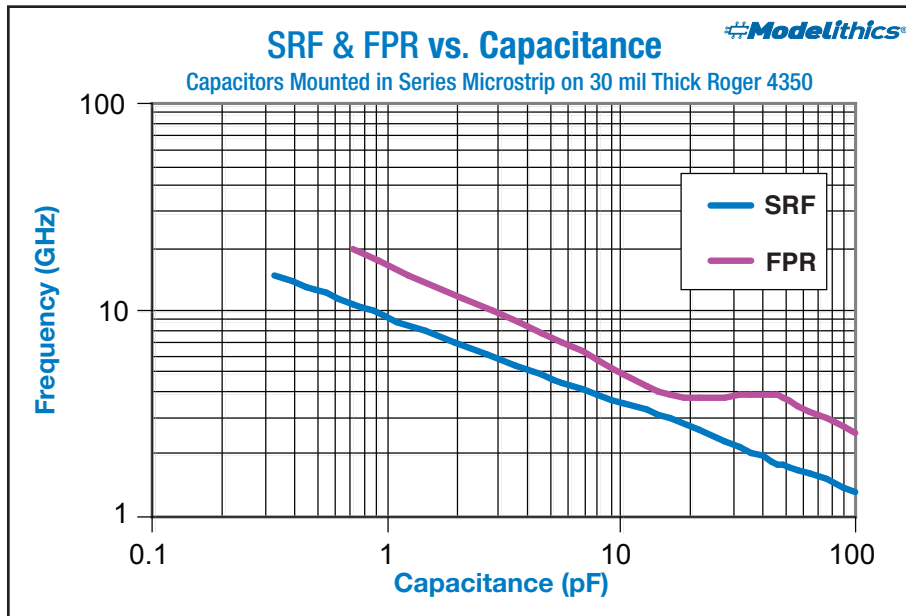
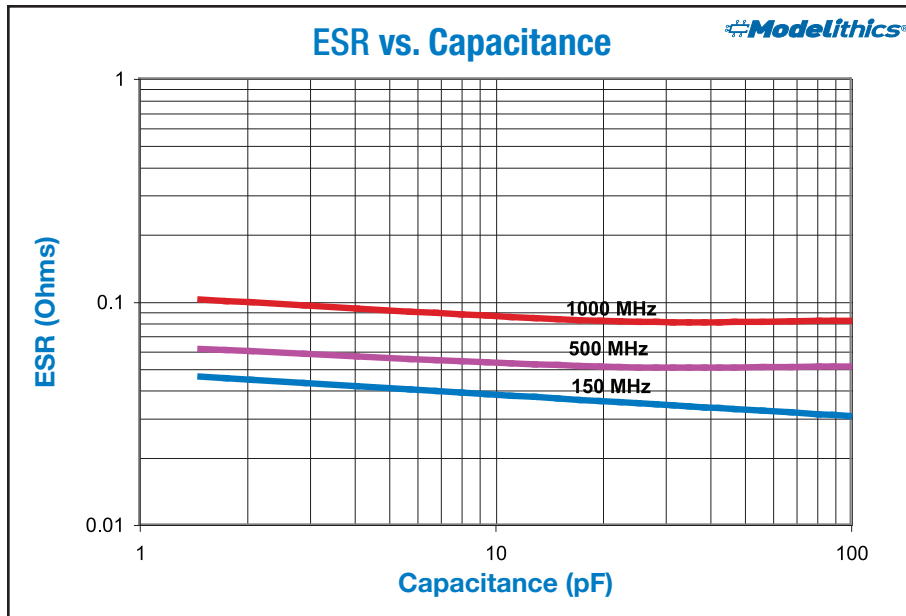

PRESIDIO ULTRA-PORCELAIN™ CAPACITORS

SIZE 0603

COMMERCIAL PART NUMBER	CAP. (pF)	TOL.	WVDC
0603UP0R1_&T1C-*	0.1	A,B	250
0603UP0R2_&T1C-*	0.2	A,B	250
0603UP0R3_&T1C-*	0.3	A,B	250
0603UP0R4_&T1C-*	0.4	A,B	250
0603UP0R5_&T1C-*	0.5	A,B	250
0603UP0R6_&T1C-*	0.6	A,B	250
0603UP0R7_&T1C-*	0.7	A,B	250
0603UP0R8_&T1C-*	0.8	A,B	250
0603UP0R9_&T1C-*	0.9	A,B	250
0603UP1R0_&T1C-*	1.0	A,B	250
0603UP1R1_&T1C-*	1.1	A,B,C	250
0603UP1R2_&T1C-*	1.2	A,B,C	250
0603UP1R5_&T1C-*	1.5	A,B,C	250
0603UP1R6_&T1C-*	1.6	A,B,C	250
0603UP1R8_&T1C-*	1.8	A,B,C	250
0603UP2R0_&T1C-*	2.0	A,B,C	250
0603UP2R2_&T1C-*	2.2	A,B,C	250
0603UP2R4_&T1C-*	2.4	A,B,C	250
0603UP2R7_&T1C-*	2.7	A,B,C	250
0603UP3R0_&T1C-*	3.0	A,B,C	250

COMMERCIAL PART NUMBER	CAP. (pF)	TOL.	WVDC
0603UP3R3_&T1C-*	3.3	A,B,C	250
0603UP3R6_&T1C-*	3.6	A,B,C	250
0603UP3R9_&T1C-*	3.9	A,B,C	250
0603UP4R3_&T1C-*	4.3	A,B,C	250
0603UP4R7_&T1C-*	4.7	A,B,C	250
0603UP5R1_&T1C-*	5.1	A,B,C	250
0603UP5R6_&T1C-*	5.6	A,B,C	250
0603UP6R2_&T1C-*	6.2	A,B,C	250
0603UP6R8_&T1C-*	6.8	A,B,C	250
0603UP7R5_&T1C-*	7.5	A,B,C	250
0603UP8R2_&T1C-*	8.2	A,B,C	250
0603UP9R1_&T1C-*	9.1	A,B,C	250
0603UP100_&T1C-*	10	F,G,J	250
0603UP110_&T1C-*	11	F,G,J	250
0603UP120_&T1C-*	12	F,G,J	250
0603UP150_&T1C-*	15	F,G,J	250
0603UP180_&T1C-*	18	F,G,J	250
0603UP200_&T1C-*	20	F,G,J	250
0603UP220_&T1C-*	22	F,G,J	250
0603UP240_&T1C-*	24	F,G,J	250

COMMERCIAL PART NUMBER	CAP. (pF)	TOL.	WVDC
0603UP270_&T1C-*	27	F,G,J	250
0603UP300_&T1C-*	30	F,G,J	250
0603UP330_&T1C-*	33	F,G,J	250
0603UP360_&T1C-*	36	F,G,J	250
0603UP390_&T1C-*	39	F,G,J	250
0603UP430_&T1C-*	43	F,G,J	250
0603UP470_&T1C-*	47	F,G,J	250
0603UP510_&T1C-*	51	F,G,J	250
0603UP560_&T1C-*	56	F,G,J	250
0603UP620_&T1C-*	62	F,G,J	250
0603UP680_&T1C-*	68	F,G,J	250
0603UP750_&T1C-*	75	F,G,J	250
0603UP820_&T1C-*	82	F,G,J	250
0603UP910_&T1C-*	91	F,G,J	250
0603UP101_&T1C-*	100	F,G,J	250

For special values please contact the factory.

PART NUMBER CODES AND DIMENSIONS

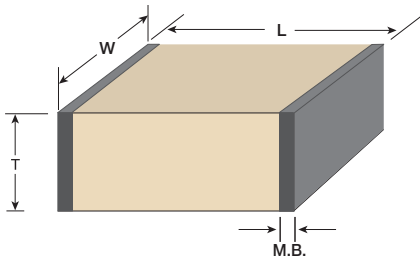

Capacitance Codes for Multilayer Capacitor

First Two Digits = Significant Figures of Capacitance in Picofarads

Third Digit = Additional Number of Zeros

Example: 100 = 10 pF
 102 = 1,000 pF
 104 = 100,000 pF

Capacitance Tolerance Codes

Code	Tolerance	Cap Range
A	± .05 pF	≤ 4.7 pF
B	± .1 pF	< 10 pF
C	± .25 pF	< 10 pF
D	± .5 pF	< 10 pF
F	± 1%	≥ 10 pF
G	± 2%	≥ 10 pF
J	± 5%	≥ 10 pF
K	± 10%	≥ 10 pF
M	± 20%	≥ 10 pF

LENGTH (L) INCH (mm)	WIDTH (W) INCH (mm)	THICKNESS (T) INCH (mm)	METALIZATION BAND (M.B.) INCH (mm)
0.063 ± 0.006 (1.60 ± 0.15)	0.032 ± 0.006 (0.81 ± 0.15)	0.035 MAX (0.89 MAX)	0.005 (0.127) min. band 0.020 (0.508) min. space

Termination Codes

Code	RoHS Comp.	Typical Application	Termination Build up	Recommended Reflow Temp.
T	Yes	Solder Reflow	100% Tin Plated Nickel Barrier Silver Base	220°C to 260°C Typical*
N	No	Solder Reflow	90% Tin/10% Lead Plated Nickel Barrier Silver Base	220°C to 260°C Typical*
P	Yes	Conductive Epoxy Non-Magnetic	Palladium-Silver	Cure Epoxy as per Manufacturer's Spec.
G	Yes	Conductive Epoxy, Wire Bondable	50 μ" Gold Typical Nickel Barrier Silver Base	Cure Epoxy as per Manufacturer's Spec.

Working Voltage

Code	WVDC	Code	WVDC
2	50	9	1000
3	100	N	1500
A	150	P	2000
4	200	Q	2500
&	250	R	3000
5	300	S	3600
6	500	U	5000
#	800	+	7200

Packaging Codes

1 = Tape and Reel
 5 = Waffle Pack

RoHS

Code	Compliant
N	No
R	Legacy (Ended 2012)
C	Yes (Started 1/2013)

Presidio's UP capacitors can be upscreened to SPACE LEVEL testing. Consult the factory for details. Some voltage derating may apply.

COMMERCIAL PART NUMBER EXAMPLE (How to Order)

0603	UP	270	J	&	T	1	C	A
Size	Dielectric (See Page 3)	Capacitance	Capacitance Tolerance	Voltage	Termination	Packaging	RoHS Compliant	Design-In Code (See Page 19)

PRESIDIO ULTRA-PORCELAIN™ CAPACITORS SIZE 0711

COMMERCIAL PART NUMBER	CAP. (pF)	TOL.	WVDC
0711UP1R0_6T1C-*	1.0	B,C,D	500
0711UP1R1_6T1C-*	1.1	B,C,D	500
0711UP1R2_6T1C-*	1.2	B,C,D	500
0711UP1R5_6T1C-*	1.5	B,C,D	500
0711UP1R6_6T1C-*	1.6	B,C,D	500
0711UP1R8_6T1C-*	1.8	B,C,D	500
0711UP2R0_6T1C-*	2.0	B,C,D	500
0711UP2R2_6T1C-*	2.2	B,C,D	500
0711UP2R4_6T1C-*	2.4	B,C,D	500
0711UP2R7_6T1C-*	2.7	B,C,D	500
0711UP3R0_6T1C-*	3.0	B,C,D	500
0711UP3R3_6T1C-*	3.3	B,C,D	500
0711UP3R6_6T1C-*	3.6	B,C,D	500
0711UP3R9_6T1C-*	3.9	B,C,D	500
0711UP4R3_6T1C-*	4.3	B,C,D	500
0711UP4R7_6T1C-*	4.7	B,C,D	500

COMMERCIAL PART NUMBER	CAP. (pF)	TOL.	WVDC
0711UP5R1_6T1C-*	5.1	B,C,D	500
0711UP5R6_6T1C-*	5.6	B,C,D	500
0711UP6R2_6T1C-*	6.2	B,C,D	500
0711UP6R8_6T1C-*	6.8	B,C,D	500
0711UP7R5_6T1C-*	7.5	B,C,D,J	500
0711UP8R2_6T1C-*	8.2	B,C,D,J	500
0711UP9R1_6T1C-*	9.1	B,C,D,J	500
0711UP100_6T1C-*	10	F,G,J,K,M	500
0711UP110_6T1C-*	11	F,G,J,K,M	500
0711UP120_6T1C-*	12	F,G,J,K,M	500
0711UP150_6T1C-*	15	F,G,J,K,M	500
0711UP180_6T1C-*	18	F,G,J,K,M	500
0711UP200_6T1C-*	20	F,G,J,K,M	500
0711UP220_6T1C-*	22	F,G,J,K,M	500
0711UP240_6T1C-*	24	F,G,J,K,M	500
0711UP270_6T1C-*	27	F,G,J,K,M	500

COMMERCIAL PART NUMBER	CAP. (pF)	TOL.	WVDC
0711UP300_6T1C-*	30	F,G,J,K,M	500
0711UP330_6T1C-*	33	F,G,J,K,M	500
0711UP360_6T1C-*	36	F,G,J,K,M	500
0711UP390_6T1C-*	39	F,G,J,K,M	500
0711UP430_6T1C-*	43	F,G,J,K,M	500
0711UP470_6T1C-*	47	F,G,J,K,M	500
0711UP510_6T1C-*	51	F,G,J,K,M	500
0711UP560_6T1C-*	56	F,G,J,K,M	500
0711UP620_6T1C-*	62	F,G,J,K,M	500
0711UP680_6T1C-*	68	F,G,J,K,M	500
0711UP750_6T1C-*	75	F,G,J,K,M	500
0711UP820_6T1C-*	82	F,G,J,K,M	500
0711UP910_6T1C-*	91	F,G,J,K,M	500
0711UP101_6T1C-*	100	F,G,J,K,M	500

For special values please contact the factory.

PART NUMBER CODES AND DIMENSIONS

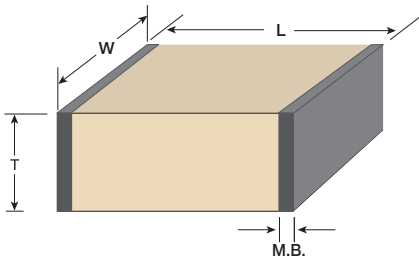

Capacitance Codes for Multilayer Capacitor

First Two Digits = Significant Figures of Capacitance in Picofarads

Third Digit = Additional Number of Zeros

Example: 100 = 10 pF
102 = 1,000 pF
104 = 100,000 pF

Capacitance Tolerance Codes

Code	Tolerance	Cap Range
A	± .05 pF	≤ 4.7 pF
B	± .1 pF	< 10 pF
C	± .25 pF	< 10 pF
D	± .5 pF	< 10 pF
F	± 1%	≥ 10 pF
G	± 2%	≥ 10 pF
J	± 5%	≥ 10 pF
K	± 10%	≥ 10 pF
M	± 20%	≥ 10 pF

LENGTH (L) INCH (mm)	WIDTH (W) INCH (mm)	THICKNESS (T) INCH (mm)	METALIZATION BAND (M.B.) INCH (mm)
0.070 ± 0.015 (1.778 ± .381)	0.105 ± 0.01 (2.667 ± 0.254)	0.090 MAX (2.286 MAX)	0.005 to 0.020 (0.127 to 0.508)

Termination Codes

Code	RoHS Comp.	Typical Application	Termination Build up	Recommended Reflow Temp.
T	Yes	Solder Reflow	100% Tin Plated Nickel Barrier Silver Base	220°C to 260°C Typical*
N	No	Solder Reflow	90% Tin/10% Lead Plated Nickel Barrier Silver Base	220°C to 260°C Typical*
P	Yes	Conductive Epoxy Non-Magnetic	Palladium-Silver	Cure Epoxy as per Manufacturer's Spec.
G	Yes	Conductive Epoxy, Wire Bondable	50 μ" Gold Typical Nickel Barrier Silver Base	Cure Epoxy as per Manufacturer's Spec.

Working Voltage

Code	WVDC	Code	WVDC
2	50	9	1000
3	100	N	1500
A	150	P	2000
4	200	Q	2500
&	250	R	3000
5	300	S	3600
6	500	U	5000
#	800	+	7200

Packaging Codes

1 = Tape and Reel
5 = Waffle Pack

RoHS

Code	Compliant
N	No
R	Legacy (Ended 2012)
C	Yes (Started 1/2013)

Presidio's UP capacitors can be upscreened to SPACE LEVEL testing. Consult the factory for details. Some voltage derating may apply.

COMMERCIAL PART NUMBER EXAMPLE (How to Order)

0711	UP	270	J	6	T	1	C	A
Size	Dielectric (See Page 3)	Capacitance	Capacitance Tolerance	Voltage	Termination	Packaging	RoHS Compliant	Design-In Code (See Page 19)



PRESIDIO COMPONENTS, INC.

7169 Construction Court, San Diego, CA 92121 • (858) 578-9390 • info@presidiocomponents.com

PRESIDIO ULTRA-PORCELAIN™ CAPACITORS SIZE 0805

COMMERCIAL PART NUMBER	CAP. (pF)	TOL.	WVDC
0805UP0R1_&T1C-*	0.1	A,B	250
0805UP0R2_&T1C-*	0.2	A,B	250
0805UP0R3_&T1C-*	0.3	A,B	250
0805UP0R4_&T1C-*	0.4	A,B	250
0805UP0R5_&T1C-*	0.5	A,B	250
0805UP0R6_&T1C-*	0.6	A,B	250
0805UP0R7_&T1C-*	0.7	A,B	250
0805UP0R8_&T1C-*	0.8	A,B	250
0805UP0R9_&T1C-*	0.9	A,B	250
0805UP1R0_&T1C-*	1.0	A,B	250
0805UP1R1_&T1C-*	1.1	A,B,C	250
0805UP1R2_&T1C-*	1.2	A,B,C	250
0805UP1R5_&T1C-*	1.5	A,B,C	250
0805UP1R6_&T1C-*	1.6	A,B,C	250
0805UP1R8_&T1C-*	1.8	A,B,C	250
0805UP2R0_&T1C-*	2.0	A,B,C	250
0805UP2R2_&T1C-*	2.2	A,B,C	250
0805UP2R4_&T1C-*	2.4	A,B,C	250
0805UP2R7_&T1C-*	2.7	A,B,C	250
0805UP3R0_&T1C-*	3.0	A,B,C	250
0805UP3R3_&T1C-*	3.3	A,B,C	250
0805UP3R6_&T1C-*	3.6	A,B,C	250

COMMERCIAL PART NUMBER	CAP. (pF)	TOL.	WVDC
0805UP3R9_&T1C-*	3.9	A,B,C	250
0805UP4R3_&T1C-*	4.3	A,B,C	250
0805UP4R7_&T1C-*	4.7	A,B,C	250
0805UP5R1_&T1C-*	5.1	A,B,C	250
0805UP5R6_&T1C-*	5.6	A,B,C	250
0805UP6R2_&T1C-*	6.2	A,B,C	250
0805UP6R8_&T1C-*	6.8	A,B,C	250
0805UP7R5_&T1C-*	7.5	A,B,C	250
0805UP8R2_&T1C-*	8.2	A,B,C	250
0805UP9R1_&T1C-*	9.1	A,B,C	250
0805UP100_&T1C-*	10	F,G,J	250
0805UP110_&T1C-*	11	F,G,J	250
0805UP120_&T1C-*	12	F,G,J	250
0805UP150_&T1C-*	15	F,G,J	250
0805UP180_&T1C-*	18	F,G,J	250
0805UP200_&T1C-*	20	F,G,J	250
0805UP220_&T1C-*	22	F,G,J	250
0805UP240_&T1C-*	24	F,G,J	250
0805UP270_&T1C-*	27	F,G,J	250
0805UP300_&T1C-*	30	F,G,J	250
0805UP330_&T1C-*	33	F,G,J	250
0805UP360_&T1C-*	36	F,G,J	250

COMMERCIAL PART NUMBER	CAP. (pF)	TOL.	WVDC
0805UP390_&T1C-*	39	F,G,J	250
0805UP430_&T1C-*	43	F,G,J	250
0805UP470_&T1C-*	47	F,G,J	250
0805UP510_&T1C-*	51	F,G,J	250
0805UP560_&T1C-*	56	F,G,J	250
0805UP620_&T1C-*	62	F,G,J	250
0805UP680_&T1C-*	68	F,G,J	250
0805UP750_&T1C-*	75	F,G,J	250
0805UP820_&T1C-*	82	F,G,J	250
0805UP910_&T1C-*	91	F,G,J	250
0805UP101_&T1C-*	100	F,G,J	250
0805UP111_&T1C-*	110	F,G,J	250
0805UP121_&T1C-*	120	F,G,J	250
0805UP151_&T1C-*	150	F,G,J	250
0805UP181_&T1C-*	180	F,G,J	250
0805UP201_&T1C-*	200	F,G,J	250
0805UP221_&T1C-*	220	F,G,J	250
0805UP241_&T1C-*	240	F,G,J	250

For special values please contact the factory.

PART NUMBER CODES AND DIMENSIONS

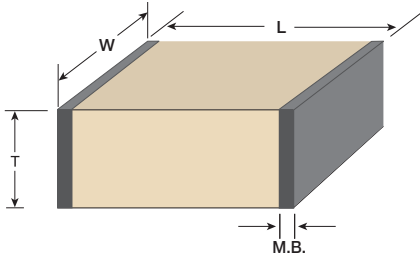

Capacitance Codes for Multilayer Capacitor

First Two Digits = Significant Figures of Capacitance in Picofarads

Third Digit = Additional Number of Zeros

Example:
 100 = 10 pF
 102 = 1,000 pF
 104 = 100,000 pF

LENGTH (L) INCH (mm)	WIDTH (W) INCH (mm)	THICKNESS (T) INCH (mm)	METALIZATION BAND (M.B.) INCH (mm)
0.080 ± 0.010 (2.03 ± 0.25)	0.050 ± 0.010 (1.27 ± 0.25)	0.055 MAX (1.40 MAX)	0.005 to 0.030 (0.127 to 0.762)

Presidio's UP capacitors can be upscreened to SPACE LEVEL testing. Consult the factory for details. Some voltage derating may apply.

Capacitance Tolerance Codes

Code	Tolerance	Cap Range
A	± .05 pF	≤ 4.7 pF
B	± .1 pF	< 10 pF
C	± .25 pF	< 10 pF
D	± .5 pF	< 10 pF
F	± 1%	≥ 10 pF
G	± 2%	≥ 10 pF
J	± 5%	≥ 10 pF
K	± 10%	≥ 10 pF
M	± 20%	≥ 10 pF

Termination Codes

Code	RoHS Comp.	Typical Application	Termination Build up	Recommended Reflow Temp.
T	Yes	Solder Reflow	100% Tin Plated Nickel Barrier Silver Base	220°C to 260°C Typical*
N	No	Solder Reflow	90% Tin/10% Lead Plated Nickel Barrier Silver Base	220°C to 260°C Typical*
P	Yes	Conductive Epoxy Non-Magnetic	Palladium-Silver	Cure Epoxy as per Manufacturer's Spec.
G	Yes	Conductive Epoxy, Wire Bondable	50 μ" Gold Typical Nickel Barrier Silver Base	Cure Epoxy as per Manufacturer's Spec.

Working Voltage

Code	WVDC	Code	WVDC
2	50	N	1000
3	100	N	1500
A	150	P	2000
4	200	Q	2500
&	250	R	3000
5	300	S	3600
6	500	U	5000
#	800	+	7200

Packaging Codes

1 = Tape and Reel
 5 = Waffle Pack

RoHS

Code	Compliant
N	No
R	Legacy (Ended 2012)
C	Yes (Started 1/2013)

COMMERCIAL PART NUMBER EXAMPLE (How to Order)

0805	UP	101	J	&	T	1	C	A
Size	Dielectric (See Page 3)	Capacitance	Capacitance Tolerance	Voltage	Termination	Packaging	RoHS Compliant	Design-In Code (See Page 19)

PRESIDIO ULTRA-PORCELAIN™ CAPACITORS

SIZE 1010

COMMERCIAL PART NUMBER	CAP. (pF)	TOL.	WVDC
1010UP0R1_6T1C-*	0.1	A,B	500
1010UP0R2_6T1C-*	0.2	A,B	500
1010UP0R3_6T1C-*	0.3	A,B	500
1010UP0R4_6T1C-*	0.4	A,B	500
1010UP0R5_6T1C-*	0.5	A,B	500
1010UP0R6_6T1C-*	0.6	A,B	500
1010UP0R7_6T1C-*	0.7	A,B	500
1010UP0R8_6T1C-*	0.8	A,B	500
1010UP0R9_6T1C-*	0.9	A,B	500
1010UP1R0_6T1C-*	1.0	A,B	500
1010UP1R1_6T1C-*	1.1	A,B,C	500
1010UP1R2_6T1C-*	1.2	A,B,C	500
1010UP1R5_6T1C-*	1.5	A,B,C	500
1010UP1R6_6T1C-*	1.6	A,B,C	500
1010UP1R8_6T1C-*	1.8	A,B,C	500
1010UP2R0_6T1C-*	2.0	A,B,C	500
1010UP2R2_6T1C-*	2.2	A,B,C	500
1010UP2R4_6T1C-*	2.4	A,B,C	500
1010UP2R7_6T1C-*	2.7	A,B,C	500
1010UP3R0_6T1C-*	3.0	A,B,C	500
1010UP3R3_6T1C-*	3.3	A,B,C	500
1010UP3R6_6T1C-*	3.6	A,B,C	500
1010UP3R9_6T1C-*	3.9	A,B,C	500
1010UP4R3_6T1C-*	4.3	A,B,C	500
1010UP4R7_6T1C-*	4.7	A,B,C	500
1010UP5R1_6T1C-*	5.1	A,B,C	500
1010UP5R6_6T1C-*	5.6	A,B,C	500
1010UP6R2_6T1C-*	6.2	A,B,C	500
1010UP6R8_6T1C-*	6.8	A,B,C	500
1010UP7R5_6T1C-*	7.5	A,B,C	500

COMMERCIAL PART NUMBER	CAP. (pF)	TOL.	WVDC
1010UP8R2_6T1C-*	8.2	A,B,C	500
1010UP9R1_6T1C-*	9.1	A,B,C	500
1010UP100_6T1C-*	10	F,G,J	500
1010UP110_6T1C-*	11	F,G,J	500
1010UP120_6T1C-*	12	F,G,J	500
1010UP150_6T1C-*	15	F,G,J	500
1010UP180_6T1C-*	18	F,G,J	500
1010UP200_6T1C-*	20	F,G,J,K,M	500
1010UP220_6T1C-*	22	F,G,J,K,M	500
1010UP240_6T1C-*	24	F,G,J,K,M	500
1010UP270_6T1C-*	27	F,G,J,K,M	500
1010UP300_6T1C-*	30	F,G,J,K,M	500
1010UP330_6T1C-*	33	F,G,J,K,M	500
1010UP360_6T1C-*	36	F,G,J,K,M	500
1010UP390_6T1C-*	39	F,G,J,K,M	500
1010UP430_6T1C-*	43	F,G,J,K,M	500
1010UP470_6T1C-*	47	F,G,J,K,M	500
1010UP510_6T1C-*	51	F,G,J,K,M	500
1010UP560_6T1C-*	56	F,G,J,K,M	500
1010UP620_6T1C-*	62	F,G,J,K,M	500
1010UP680_6T1C-*	68	F,G,J,K,M	500
1010UP750_6T1C-*	75	F,G,J,K,M	500
1010UP820_6T1C-*	82	F,G,J,K,M	500
1010UP910_6T1C-*	91	F,G,J,K,M	500
1010UP101_6T1C-*	100	F,G,J,K,M	500
1010UP111_5T1C-*	110	F,G,J,K,M	300
1010UP121_5T1C-*	120	F,G,J,K,M	300
1010UP151_5T1C-*	150	F,G,J,K,M	300
1010UP181_5T1C-*	180	F,G,J,K,M	300
1010UP201_5T1C-*	200	F,G,J,K,M	300

COMMERCIAL PART NUMBER	CAP. (pF)	TOL.	WVDC
1010UP221_4T1C-*	220	F,G,J,K,M	200
1010UP241_4T1C-*	240	F,G,J,K,M	200
1010UP271_4T1C-*	270	F,G,J,K,M	200
1010UP301_4T1C-*	300	F,G,J,K,M	200
1010UP331_4T1C-*	330	F,G,J,K,M	200
1010UP361_4T1C-*	360	F,G,J,K,M	200
1010UP391_4T1C-*	390	F,G,J,K,M	200
1010UP431_4T1C-*	430	F,G,J,K,M	200
1010UP471_4T1C-*	470	F,G,J,K,M	200
1010UP511_3T1C-*	510	F,G,J,K,M	100
1010UP561_3T1C-*	560	F,G,J,K,M	100
1010UP621_3T1C-*	620	F,G,J,K,M	100
1010UP681_2T1C-*	680	F,G,J,K,M	50
1010UP751_2T1C-*	750	F,G,J,K,M	50
1010UP821_2T1C-*	820	F,G,J,K,M	50
1010UP911_2T1C-*	910	F,G,J,K,M	50
1010UP102_2T1C-*	1000	F,G,J,K,M	50
1010NPO112_2T1C-*	1100	F,G,J,K,M	50
1010NPO122_2T1C-*	1200	F,G,J,K,M	50
1010NPO152_2T1C-*	1500	F,G,J,K,M	50
1010NPO182_2T1C-*	1800	F,G,J,K,M	50
1010NPO222_2T1C-*	2200	F,G,J,K,M	50
1010NPO272_2T1C-*	2700	F,G,J,K,M	50
1010NPO302_2T1C-*	3000	F,G,J,K,M	50
1010NPO332_2T1C-*	3300	F,G,J,K,M	50
1010NPO392_2T1C-*	3900	F,G,J,K,M	50
1010NPO472_2T1C-*	4700	F,G,J,K,M	50
1010NPO512_2T1C-*	5100	F,G,J,K,M	50

For special values please contact the factory.

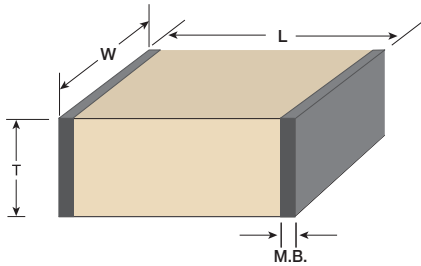

Capacitance Codes for Multilayer Capacitor

First Two Digits = Significant Figures of Capacitance in Picofarads

Third Digit = Additional Number of Zeros

Example: 100 = 10 pF
102 = 1,000 pF
104 = 100,000 pF

Capacitance Tolerance Codes

Code	Tolerance	Cap Range
A	± .05 pF	≤ 4.7 pF
B	± .1 pF	< 10 pF
C	± .25 pF	< 10 pF
D	± .5 pF	< 10 pF
F	± 1%	≥ 10 pF
G	± 2%	≥ 10 pF
J	± 5%	≥ 10 pF
K	± 10%	≥ 10 pF
M	± 20%	≥ 10 pF

LENGTH (L) INCH (mm)	WIDTH (W) INCH (mm)	THICKNESS (T) INCH (mm)	METALIZATION BAND (M.B.) INCH (mm)
0.110 + 0.020/ - 0.010 (2.794 + 0.508/ - 0.254)	0.110 ± 0.015 (2.794 ± 0.381)	0.102 MAX (2.591 MAX)	0.005 to 0.030 (0.127 to 0.762)

Termination Codes

Code	RoHS Comp.	Typical Application	Termination Build up	Recommended Reflow Temp.
T	Yes	Solder Reflow	100% Tin Plated Nickel Barrier Silver Base	220°C to 260°C Typical*
N	No	Solder Reflow	90% Tin/10% Lead Plated Nickel Barrier Silver Base	220°C to 260°C Typical*
P	Yes	Conductive Epoxy Non-Magnetic	Palladium-Silver	Cure Epoxy as per Manufacturer's Spec.
G	Yes	Conductive Epoxy, Wire Bondable	50 μ" Gold Typical Nickel Barrier Silver Base	Cure Epoxy as per Manufacturer's Spec.

Working Voltage

Code	WVDC	Code	WVDC
2	50	9	1000
3	100	N	1500
A	150	P	2000
4	200	Q	2500
&	250	R	3000
5	300	S	3600
6	500	U	5000
#	800	+	7200

Packaging Codes

1 = Tape and Reel
5 = Waffle Pack

RoHS

Code	Compliant
N	No
R	Legacy (Ended 2012)
C	Yes (Started 1/2013)

COMMERCIAL PART NUMBER EXAMPLE (How to Order)

1010	UP	101	J	6	T	1	C	A
Size	Dielectric (See Page 3)	Capacitance	Capacitance Tolerance	Voltage	Termination	Packaging	RoHS Compliant	Design-In Code (See Page 19)

PRESIDIO ULTRA-PORCELAIN™ CAPACITORS

SIZE 2525

COMMERCIAL PART NUMBER	CAP. (pF)	TOL.	WVDC
2525UP0R1_QT1C-*	0.1	B,C,D	2.5K/3.6K
2525UP0R2_QT1C-*	0.2	B,C,D	2.5K/3.6K
2525UP0R3_QT1C-*	0.3	B,C,D	2.5K/3.6K
2525UP0R4_QT1C-*	0.4	B,C,D	2.5K/3.6K
2525UP0R5_QT1C-*	0.5	B,C,D	2.5K/3.6K
2525UP0R6_QT1C-*	0.6	B,C,D	2.5K/3.6K
2525UP0R7_QT1C-*	0.7	B,C,D	2.5K/3.6K
2525UP0R8_QT1C-*	0.8	B,C,D	2.5K/3.6K
2525UP0R9_QT1C-*	0.9	B,C,D	2.5K/3.6K
2525UP1R0_QT1C-*	1.0	B,C,D	2.5K/3.6K
2525UP1R1_QT1C-*	1.1	B,C,D	2.5K/3.6K
2525UP1R2_QT1C-*	1.2	B,C,D	2.5K/3.6K
2525UP1R5_QT1C-*	1.5	B,C,D	2.5K/3.6K
2525UP1R6_QT1C-*	1.6	B,C,D	2.5K/3.6K
2525UP1R8_QT1C-*	1.8	B,C,D	2.5K/3.6K
2525UP2R0_QT1C-*	2.0	B,C,D	2.5K/3.6K
2525UP2R2_QT1C-*	2.2	B,C,D	2.5K/3.6K
2525UP2R4_QT1C-*	2.4	B,C,D	2.5K/3.6K
2525UP2R7_QT1C-*	2.7	B,C,D	2.5K/3.6K
2525UP3R0_QT1C-*	3.0	B,C,D	2.5K/3.6K
2525UP3R3_QT1C-*	3.3	B,C,D	2.5K/3.6K
2525UP3R6_QT1C-*	3.6	B,C,D	2.5K/3.6K
2525UP3R9_QT1C-*	3.9	B,C,D	2.5K/3.6K
2525UP4R3_QT1C-*	4.3	B,C,D	2.5K/3.6K
2525UP4R7_QT1C-*	4.7	B,C,D	2.5K/3.6K
2525UP5R1_QT1C-*	5.1	B,C,D	2.5K/3.6K
2525UP5R6_QT1C-*	5.6	B,C,D	2.5K/3.6K
2525UP6R2_QT1C-*	6.2	B,C,D	2.5K/3.6K
2525UP6R8_QT1C-*	6.8	B,C,D	2.5K/3.6K
2525UP7R5_QT1C-*	7.5	B,C,D	2.5K/3.6K

COMMERCIAL PART NUMBER	CAP. (pF)	TOL.	WVDC
2525UP8R2_QT1C-*	8.2	B,C,D	2.5K/3.6K
2525UP9R1_QT1C-*	9.1	B,C,D	2.5K/3.6K
2525UP100_QT1C-*	10	F,G,J,K,M	2.5K/3.6K
2525UP110_QT1C-*	11	F,G,J,K,M	2.5K/3.6K
2525UP120_QT1C-*	12	F,G,J,K,M	2.5K/3.6K
2525UP150_QT1C-*	15	F,G,J,K,M	2.5K/3.6K
2525UP180_QT1C-*	18	F,G,J,K,M	2.5K/3.6K
2525UP200_QT1C-*	20	F,G,J,K,M	2.5K/3.6K
2525UP220_QT1C-*	22	F,G,J,K,M	2.5K/3.6K
2525UP240_QT1C-*	24	F,G,J,K,M	2.5K/3.6K
2525UP270_QT1C-*	27	F,G,J,K,M	2.5K/3.6K
2525UP300_QT1C-*	30	F,G,J,K,M	2.5K/3.6K
2525UP330_QT1C-*	33	F,G,J,K,M	2.5K/3.6K
2525UP360_QT1C-*	36	F,G,J,K,M	2.5K/3.6K
2525UP390_QT1C-*	39	F,G,J,K,M	2.5K/3.6K
2525UP430_QT1C-*	43	F,G,J,K,M	2.5K/3.6K
2525UP470_QT1C-*	47	F,G,J,K,M	2.5K/3.6K
2525UP510_QT1C-*	51	F,G,J,K,M	2.5K/3.6K
2525UP560_QT1C-*	56	F,G,J,K,M	2.5K/3.6K
2525UP620_QT1C-*	62	F,G,J,K,M	2.5K/3.6K
2525UP680_QT1C-*	68	F,G,J,K,M	2.5K/3.6K
2525UP750_QT1C-*	75	F,G,J,K,M	2.5K/3.6K
2525UP820_QT1C-*	82	F,G,J,K,M	2.5K/3.6K
2525UP910_QT1C-*	91	F,G,J,K,M	2.5K/3.6K
2525UP101_QT1C-*	100	F,G,J,K,M	2.5K/3.6K
2525UP111_QT1C-*	110	F,G,J,K,M	2.5K/3.6K
2525UP121_QT1C-*	120	F,G,J,K,M	2.5K/3.6K
2525UP151_QT1C-*	150	F,G,J,K,M	2.5K/3.6K
2525UP181_QT1C-*	180	F,G,J,K,M	2.5K/3.6K
2525UP201_QT1C-*	200	F,G,J,K,M	2.5K/3.6K

COMMERCIAL PART NUMBER	CAP. (pF)	TOL.	WVDC
2525UP221_QT1C-*	220	F,G,J,K,M	2.5K/3.0K
2525UP241_QT1C-*	240	F,G,J,K,M	2.5K/3.0K
2525UP271_QT1C-*	270	F,G,J,K,M	2.5K/3.0K
2525UP301_PT1C-*	300	F,G,J,K,M	1.5K/2.0K
2525UP331_PT1C-*	330	F,G,J,K,M	1.5K/2.0K
2525UP361_PT1C-*	360	F,G,J,K,M	1.5K/2.0K
2525UP391_PT1C-*	390	F,G,J,K,M	1.5K/2.0K
2525UP431_PT1C-*	430	F,G,J,K,M	1.5K/2.0K
2525UP471_PT1C-*	470	F,G,J,K,M	1.5K/2.0K
2525UP511_NT1C-*	510	F,G,J,K,M	1.0K/1.5K
2525UP561_NT1C-*	560	F,G,J,K,M	1.0K/1.5K
2525UP621_NT1C-*	620	F,G,J,K,M	1.0K/1.5K
2525UP681_NT1C-*	680	F,G,J,K,M	1.0K/1.5K
2525UP751_NT1C-*	750	F,G,J,K,M	1.0K/1.5K
2525UP821_NT1C-*	820	F,G,J,K,M	1.0K/1.5K
2525UP911_NT1C-*	910	F,G,J,K,M	1.0K/1.5K
2525UP102_NT1C-*	1000	F,G,J,K,M	1.0K/1.5K
2525NPO112_NT1C-*	1100	F,G,J,K,M	1.0K/1.5K
2525NPO122_NT1C-*	1200	F,G,J,K,M	1.0K/1.5K
2525NPO152_#T1C-*	1500	F,G,J,K,M	0.5K/0.8K
2525NPO182_#T1C-*	1800	F,G,J,K,M	0.5K/0.8K
2525NPO222_6T1C-*	2200	F,G,J,K,M	0.3K/0.5K
2525NPO272_6T1C-*	2700	F,G,J,K,M	0.3K/0.5K
2525NPO302_6T1C-*	3000	F,G,J,K,M	0.3K/0.5K
2525NPO332_6T1C-*	3300	F,G,J,K,M	0.3K/0.5K
2525NPO392_6T1C-*	3900	F,G,J,K,M	0.3K/0.5K
2525NPO472_6T1C-*	4700	F,G,J,K,M	0.3K/0.5K
2525NPO512_6T1C-*	5100	F,G,J,K,M	0.3K/0.5K

For special values please contact the factory.

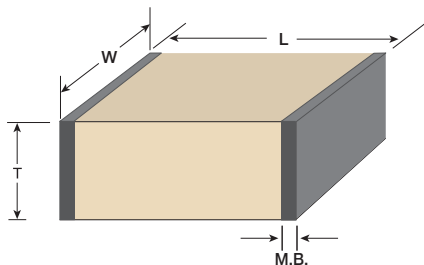

Capacitance Codes for Multilayer Capacitor

First Two Digits = Significant Figures of Capacitance in Picofarads

Third Digit = Additional Number of Zeros

Example:
 100 = 10 pF
 102 = 1,000 pF
 104 = 100,000 pF

Capacitance Tolerance Codes

Code	Tolerance	Cap Range
A	± .05 pF	≤ 4.7 pF
B	± .1 pF	< 10 pF
C	± .25 pF	< 10 pF
D	± .5 pF	< 10 pF
F	± 1%	≥ 10 pF
G	± 2%	≥ 10 pF
J	± 5%	≥ 10 pF
K	± 10%	≥ 10 pF
M	± 20%	≥ 10 pF

LENGTH (L) INCH (mm)	WIDTH (W) INCH (mm)	THICKNESS (T) INCH (mm)	METALIZATION BAND (M.B.) INCH (mm)
0.250 ± 0.020 (6.35 ± 0.508)	0.250 ± 0.020 (6.35 ± 0.508)	0.150 MAX (3.81 MAX)	0.010 to 0.040 (0.254 to 1.016)

Termination Codes

Code	RoHS Comp.	Typical Application	Termination Build up	Recommended Reflow Temp.
T	Yes	Solder Reflow	100% Tin Plated Nickel Barrier Silver Base	220°C to 260°C Typical*
N	No	Solder Reflow	90% Tin/10% Lead Plated Nickel Barrier Silver Base	220°C to 260°C Typical*
P	Yes	Conductive Epoxy Non-Magnetic	Palladium-Silver	Cure Epoxy as per Manufacturer's Spec.
G	Yes	Conductive Epoxy, Wire Bondable	50 μ" Gold Typical Nickel Barrier Silver Base	Cure Epoxy as per Manufacturer's Spec.

Working Voltage

Code	WVDC	Code	WVDC
2	50	9	1000
3	100	N	1500
A	150	P	2000
4	200	Q	2500
&	250	R	3000
5	300	S	3600
6	500	U	5000
#	800	+	7200

Packaging Codes

1 = Tape and Reel
 5 = Waffle Pack

RoHS

Code	Compliant
N	No
R	Legacy (Ended 2012)
C	Yes (Started 1/2013)

COMMERCIAL PART NUMBER EXAMPLE (How to Order)

2525	UP	101	J	Q	T	1	C	A
Size	Dielectric (See Page 3)	Capacitance	Capacitance Tolerance	Voltage	Termination	Packaging	RoHS Compliant	Design-In Code (See Page 19)

PRESIDIO ULTRA-PORCELAIN™ CAPACITORS

SIZE 3838

COMMERCIAL PART NUMBER	CAP. (pF)	TOL.	WVDC
3838UP1R0_ST1C-*	1.0	B,C,D	3.6K/7.2K
3838UP1R1_ST1C-*	1.1	B,C,D	3.6K/7.2K
3838UP1R2_ST1C-*	1.2	B,C,D	3.6K/7.2K
3838UP1R5_ST1C-*	1.5	B,C,D	3.6K/7.2K
3838UP1R6_ST1C-*	1.6	B,C,D	3.6K/7.2K
3838UP1R8_ST1C-*	1.8	B,C,D	3.6K/7.2K
3838UP2R0_ST1C-*	2.0	B,C,D	3.6K/7.2K
3838UP2R2_ST1C-*	2.2	B,C,D	3.6K/7.2K
3838UP2R4_ST1C-*	2.4	B,C,D	3.6K/7.2K
3838UP2R7_ST1C-*	2.7	B,C,D	3.6K/7.2K
3838UP3R0_ST1C-*	3.0	B,C,D	3.6K/7.2K
3838UP3R3_ST1C-*	3.3	B,C,D	3.6K/7.2K
3838UP3R6_ST1C-*	3.6	B,C,D	3.6K/7.2K
3838UP3R9_ST1C-*	3.9	B,C,D	3.6K/7.2K
3838UP4R3_ST1C-*	4.3	B,C,D	3.6K/7.2K
3838UP4R7_ST1C-*	4.7	B,C,D	3.6K/7.2K
3838UP5R1_ST1C-*	5.1	B,C,D	3.6K/7.2K
3838UP5R6_ST1C-*	5.6	B,C,D	3.6K/7.2K
3838UP6R2_ST1C-*	6.2	B,C,D	3.6K/7.2K
3838UP6R8_ST1C-*	6.8	B,C,D	3.6K/7.2K
3838UP7R5_ST1C-*	7.5	B,C,D	3.6K/7.2K
3838UP8R2_ST1C-*	8.2	B,C,D	3.6K/7.2K
3838UP9R1_ST1C-*	9.1	B,C,D	3.6K/7.2K
3838UP100_ST1C-*	10	F,G,J,K,M	3.6K/7.2K
3838UP110_ST1C-*	11	F,G,J,K,M	3.6K/7.2K
3838UP120_ST1C-*	12	F,G,J,K,M	3.6K/7.2K
3838UP150_ST1C-*	15	F,G,J,K,M	3.6K/7.2K
3838UP180_ST1C-*	18	F,G,J,K,M	3.6K/7.2K
3838UP200_ST1C-*	20	F,G,J,K,M	3.6K/7.2K
3838UP220_ST1C-*	22	F,G,J,K,M	3.6K/7.2K

COMMERCIAL PART NUMBER	CAP. (pF)	TOL.	WVDC
3838UP240_ST1C-*	24	F,G,J,K,M	3.6K/7.2K
3838UP270_ST1C-*	27	F,G,J,K,M	3.6K/7.2K
3838UP300_ST1C-*	30	F,G,J,K,M	3.6K/7.2K
3838UP330_ST1C-*	33	F,G,J,K,M	3.6K/7.2K
3838UP360_ST1C-*	36	F,G,J,K,M	3.6K/7.2K
3838UP390_ST1C-*	39	F,G,J,K,M	3.6K/7.2K
3838UP430_ST1C-*	43	F,G,J,K,M	3.6K/7.2K
3838UP470_ST1C-*	47	F,G,J,K,M	3.6K/7.2K
3838UP510_ST1C-*	51	F,G,J,K,M	3.6K/7.2K
3838UP560_ST1C-*	56	F,G,J,K,M	3.6K/7.2K
3838UP620_ST1C-*	62	F,G,J,K,M	3.6K/7.2K
3838UP680_ST1C-*	68	F,G,J,K,M	3.6K/7.2K
3838UP750_ST1C-*	75	F,G,J,K,M	3.6K/7.2K
3838UP820_ST1C-*	82	F,G,J,K,M	3.6K/7.2K
3838UP910_ST1C-*	91	F,G,J,K,M	3.6K/7.2K
3838UP101_ST1C-*	100	F,G,J,K,M	3.6K/7.2K
3838UP111_ST1C-*	110	F,G,J,K,M	3.6K/5.0K
3838UP121_ST1C-*	120	F,G,J,K,M	3.6K/5.0K
3838UP151_ST1C-*	150	F,G,J,K,M	3.6K/5.0K
3838UP181_ST1C-*	180	F,G,J,K,M	3.6K/5.0K
3838UP201_ST1C-*	200	F,G,J,K,M	3.6K/5.0K
3838UP221_ST1C-*	220	F,G,J,K,M	3.6K/5.0K
3838UP241_ST1C-*	240	F,G,J,K,M	3600
3838UP271_ST1C-*	270	F,G,J,K,M	3600
3838UP301_ST1C-*	300	F,G,J,K,M	3600
3838UP331_ST1C-*	330	F,G,J,K,M	3600
3838UP361_ST1C-*	360	F,G,J,K,M	3600
3838UP391_ST1C-*	390	F,G,J,K,M	3600
3838UP431_QT1C-*	430	F,G,J,K,M	2500
3838UP471_QT1C-*	470	F,G,J,K,M	2500

COMMERCIAL PART NUMBER	CAP. (pF)	TOL.	WVDC
3838UP511_QT1C-*	510	F,G,J,K,M	2500
3838UP561_QT1C-*	560	F,G,J,K,M	2500
3838UP621_QT1C-*	620	F,G,J,K,M	2500
3838UP681_QT1C-*	680	F,G,J,K,M	2500
3838UP751_QT1C-*	750	F,G,J,K,M	2500
3838UP821_9T1C-*	820	F,G,J,K,M	1000
3838UP911_9T1C-*	910	F,G,J,K,M	1000
3838UP102_9T1C-*	1000	F,G,J,K,M	1000
3838NPO112_9T1C-*	1100	F,G,J,K,M	1000
3838NPO122_9T1C-*	1200	F,G,J,K,M	1000
3838NPO152_9T1C-*	1500	F,G,J,K,M	1000
3838NPO182_9T1C-*	1800	F,G,J,K,M	1000
3838NPO222_9T1C-*	2200	F,G,J,K,M	1000
3838NPO272_6T1C-*	2700	F,G,J,K,M	500
3838NPO302_6T1C-*	3000	F,G,J,K,M	500
3838NPO332_6T1C-*	3300	F,G,J,K,M	500
3838NPO392_6T1C-*	3900	F,G,J,K,M	500
3838NPO472_6T1C-*	4700	F,G,J,K,M	500
3838NPO512_6T1C-*	5100	F,G,J,K,M	500
3838NPO562_4T1C-*	5600	G,J,K,M	200
3838NPO622_4T1C-*	6200	G,J,K,M	200
3838NPO682_4T1C-*	6800	G,J,K,M	200
3838NPO722_4T1C-*	7200	G,J,K,M	200
3838NPO822_4T1C-*	8200	G,J,K,M	200
3838NPO912_4T1C-*	9100	G,J,K,M	200
3838NPO103_4T1C-*	10,000	G,J,K,M	200

Presidio's UP capacitors can be upscreened to SPACE LEVEL testing. Consult the factory for details. Some voltage derating may apply.

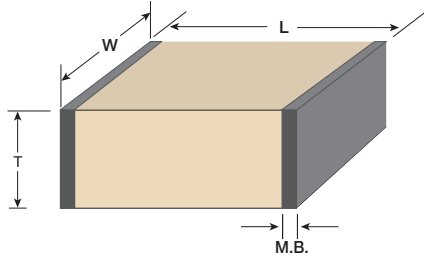

Capacitance Codes for Multilayer Capacitor

First Two Digits = Significant Figures of Capacitance in Picofarads

Third Digit = Additional Number of Zeros

Example:

- 100 = 10 pF
- 102 = 1,000 pF
- 104 = 100,000 pF

Capacitance Tolerance Codes

Code	Tolerance	Cap Range
A	± .05 pF	≤ 4.7 pF
B	± .1 pF	< 10 pF
C	± .25 pF	< 10 pF
D	± .5 pF	< 10 pF
F	± 1%	≥ 10 pF
G	± 2%	≥ 10 pF
J	± 5%	≥ 10 pF
K	± 10%	≥ 10 pF
M	± 20%	≥ 10 pF

LENGTH (L) INCH (mm)	WIDTH (W) INCH (mm)	THICKNESS (T) INCH (mm)	METALIZATION BAND (M.B.) INCH (mm)
0.380 ± 0.020 (9.652 ± 0.508)	0.380 ± 0.020 (9.652 ± 0.508)	0.180 MAX (4.572 MAX)	0.010 to 0.040 (0.254 to 1.016)

Termination Codes

Code	RoHS Comp.	Typical Application	Termination Build up	Recommended Reflow Temp.
T	Yes	Solder Reflow	100% Tin Plated Nickel Barrier Silver Base	220°C to 260°C Typical*
N	No	Solder Reflow	90% Tin/10% Lead Plated Nickel Barrier Silver Base	220°C to 260°C Typical*
P	Yes	Conductive Epoxy Non-Magnetic	Palladium-Silver	Cure Epoxy as per Manufacturer's Spec.
G	Yes	Conductive Epoxy, Wire Bondable	50 μ" Gold Typical Nickel Barrier Silver Base	Cure Epoxy as per Manufacturer's Spec.

Working Voltage

Code	WVDC	Code	WVDC
2	50	9	1000
3	100	N	1500
A	150	P	2000
4	200	Q	2500
&	250	R	3000
5	300	S	3600
6	500	U	5000
#	800	+	7200

Packaging Codes

1 = Tape and Reel
5 = Waffle Pack

RoHS

Code	Compliant
N	No
R	Legacy (Ended 2012)
C	Yes (Started 1/2013)

COMMERCIAL PART NUMBER EXAMPLE (How to Order)

3838	UP	101	J	S	T	1	C	A
Size	Dielectric (See Page 3)	Capacitance	Capacitance Tolerance	Voltage	Termination	Packaging	RoHS Compliant	Design-In Code (See Page 19)

MILITARY SPECIFICATION PART NUMBERS

CDR11 AND CDR12 – MIL-PRF-55681

CAPACITOR CHARACTERISTICS – SIZE 0505

Type Designation	Capacitance (pF)	Cap. Tolerance	Rated Temp. & Voltage-Temp. Limits	Rated Voltage (V dc)
CDR1-B-0R1-B --	0.1	B	BG, BP	50, 150
CDR1-B-0R2-B --	0.2	B	BG, BP	50, 150
CDR1-B-0R3 - - - -	0.3	B, C	BG, BP	50, 150
CDR1-B-0R4 - - - -	0.4	B, C	BG, BP	50, 150
CDR1-B-0R5 - - - -	0.5	B, C, D	BG, BP	50, 150
CDR1-B-0R6 - - - -	0.6	B, C, D	BG, BP	50, 150
CDR1-B-0R7 - - - -	0.7	B, C, D	BG, BP	50, 150
CDR1-B-0R8 - - - -	0.8	B, C, D	BG, BP	50, 150
CDR1-B-0R9 - - - -	0.9	B, C, D	BG, BP	50, 150
CDR1-B-1R0 - - - -	1	B, C, D	BG, BP	50, 150
CDR1-B-1R1 - - - -	1.1	B, C, D	BG, BP	50, 150
CDR1-B-1R2 - - - -	1.2	B, C, D	BG, BP	50, 150
CDR1-B-1R3 - - - -	1.3	B, C, D	BC, BP	50, 150
CDR1-B-1R4 - - - -	1.4	B, C, D	BG, BP	50, 150
CDR1-B-1R5 - - - -	1.5	B, C, D	BG, BP	50, 150
CDR1-B-1R6 - - - -	1.6	B, C, D	BG, BP	50, 150
CDR1-B-1R7 - - - -	1.7	B, C, D	BG, BP	50, 150
CDR1-B-1R8 - - - -	1.8	B, C, D	BG, BP	50, 150
CDR1-B-1R9 - - - -	1.9	B, C, D	BG, BP	50, 150
CDR1-B-2R0 - - - -	2	B, C, D	BG, BP	50, 150
CDR1-B-2R1 - - - -	2.1	B, C, D	BG, BP	50, 150
CDR1-B-2R2 - - - -	2.2	B, C, D	BG, BP	50, 150
CDR1-B-2R4 - - - -	2.4	B, C, D	BG, BP	50, 150
CDR1-B-2R7 - - - -	2.7	B, C, D	BG, BP	50, 150
CDR1-B-3R0 - - - -	3	B, C, D	BC, BP	50, 150
CDR1-B-3R3 - - - -	3.3	B, C, D	BG, BP	50, 150
CDR1-B-3R6 - - - -	3.6	B, C, D	BG, BP	50, 150
CDR1-B-3R9 - - - -	3.9	B, C, D	BG, BP	50, 150
CDR1-B-4R3 - - - -	4.3	8, C, D	BG, BP	50, 150
CDR1-B-4R7 - - - -	4.7	B, C, D	BG, BP	50, 150
CDR1-B-5R1 - - - -	5.1	B, C, D	BG, BP	50, 150
CDR1-B-5R6 - - - -	5.6	B, C, D	BG, BP	50, 150
CDR1-B-6R2 - - - -	6.2	B, C, D	BG, BP	50, 150
CDR1-B-6R8 - - - -	6.8	B, C, J, K, M	BC, BP	50, 150
CDR1-B-7R5 - - - -	7.5	B, C, J, K, M	BG, BP	50, 150
CDR1-B-8R2 - - - -	8.2	B, C, J, K, M	BG, BP	50, 150
CDR1-B-9R1 - - - -	9.1	B, C, J, K, M	BG, BP	50, 150
CDR1-B-100 - - - -	10	F, G, J, K, M	BG, BP	50, 150
CDR1-B-110 - - - -	11	F, G, J, K, M	BG, BP	50, 150
CDR1-B-120 - - - -	12	F, G, J, K, M	BG, BP	50, 150
CDR1-B-130 - - - -	13	F, G, J, K, M	BG, BP	50, 150
CDR1-B-150 - - - -	15	F, G, J, K, M	BG, BP	50, 150
CDR1-B-160 - - - -	16	F, G, J, K, M	BG, BP	50, 150

SPACE LEVEL 'S'

DSCC DWG 06019

Type Designation	Capacitance (pF)	Cap. Tolerance	Rated Temp. & Voltage-Temp. Limits	Rated Voltage (V dc)
CDR1-B-180 - - - -	18	F, G, J, K, M	BG, BP	50, 150
CDR1-B-200 - - - -	20	F, G, J, K, M	BG, BP	50, 150
CDR1-B-220 - - - -	22	F, G, J, K, M	BG, BP	50, 150
CDR1-B-240 - - - -	24	F, G, J, K, M	BG, BP	50, 150
CDR1-B-270 - - - -	27	F, G, J, K, M	BG, BP	50, 150
CDR1-B-300 - - - -	30	F, G, J, K, M	BG, BP	50, 150
CDR1-B-330 - - - -	33	F, G, J, K, M	BG, BP	50, 150
CDR1-B-360 - - - -	36	F, G, J, K, M	BG, BP	50, 150
CDR1-B-390 - - - -	39	F, G, J, K, M	BG, BP	50, 150
CDR1-B-430 - - - -	43	F, G, J, K, M	BG, BP	50, 150
CDR1-B-470 - - - -	47	F, G, J, K, M	BG, BP	50, 150
CDR1-B-510 - - - -	51	F, G, J, K, M	BG, BP	50, 150
CDR1-B-560 - - - -	56	F, G, J, K, M	BG, BP	50, 150
CDR1-B-620 - - - -	62	F, G, J, K, M	BG, BP	50, 150
CDR1-B-680 - - - -	68	F, G, J, K, M	BG, BP	50, 150
CDR1-B-750 - - - -	75	F, G, J, K, M	BG, BP	50, 150
CDR1-B-820 - - - -	82	F, G, J, K, M	BG, BP	50, 150
CDR1-B-910 - - - -	91	F, G, J, K, M	BG, BP	50, 150
CDR1-B-101 - - - -	100	F, G, J, K, M	BG, BP	50, 150
CDR1-BP111A - - -	110	F, G, J, K, M	BP	50, 100
CDR1-BP121A - - -	120	F, G, J, K, M	BP	50, 100
CDR1-BP131A - - -	130	F, G, J, K, M	BP	50, 100
CDR1-BP151A - - -	150	F, G, J, K, M	BP	50, 100
CDR1-BP161A - - -	160	F, G, J, K, M	BP	50, 100
CDR1-BP181A - - -	180	F, G, J, K, M	BP	50, 100
CDR1-BP201A - - -	200	F, G, J, K, M	BP	50, 100
CDR1-BP221A - - -	220	F, G, J, K, M	BP	50, 100
CDR1-BP241A - - -	240	F, G, J, K, M	BP	50, 100
CDR1-BP271A - - -	270	F, G, J, K, M	BP	50, 100
CDR1-BP301A - - -	300	F, G, J, K, M	BP	50, 100
CDR1-BP331A - - -	330	F, G, J, K, M	BP	50, 100
CDR1-BP361A - - -	360	F, G, J, K, M	BP	50, 100
CDR1-BP391A - - -	390	F, G, J, K, M	BP	50, 100
CDR1-BP431A - - -	430	F, G, J, K, M	BP	50, 100
CDR1-BP471A - - -	470	F, G, J, K, M	BP	50, 100
CDR1-BP511A - - -	510	F, G, J, K, M	BP	50, 100
CDR1-BP561A - - -	560	F, G, J, K, M	BP	50, 100
CDR1-BP621A - - -	620	F, G, J, K, M	BP	50, 100
CDR1-BP681A - - -	680	F, G, J, K, M	BP	50, 100
CDR1-BP751A - - -	750	F, G, J, K, M	BP	50, 100
CDR1-BP821A - - -	820	F, G, J, K, M	BP	50, 100
CDR1-BP911A - - -	910	F, G, J, K, M	BP	50, 100
CDR1-BP102A - - -	1,000	F, G, J, K, M	BP	50, 100

PART NUMBER EXAMPLE (How to Order)

Visit our website for the complete MIL-PRF-55681 Specification

CDR11		BG	101	A	C	M	S
Mil Style	Voltage Temperature Limits	Capacitance	Rated Voltage Code	Cap Tolerance Code	Termination Finish		Failure Rate Level
CDR11 CDR12	BG = 90 ± 20 ppm / °C	3 Digit EIA Code	A = 50V B = 100V K = 150V	B = ± .10 pF C = ± .25 pF D = ± .50 pF F = ± 1% G = ± 2% J = ± 5% K = ± 10% M = ± 20%	M = Palladium/Silver	CDR11 Only	M = 1.0%
	BP = 0 ± 30 ppm / °C				S = Solder Coated, Final with a Minimum of 4% Lead		
Size 0505					U = Base Metalization, Barrier Metal, Solder Coated (Tin/Lead Alloy with a Minimum of 4% Lead)		
					W = Base Metalization, Barrier Metal, Tinned (Tin or Tin/Lead Alloy)		
					Z = Base Metalization, Barrier Metal, Tinned (Tin/Lead Alloy with Minimum of 4% Lead)		

DIMENSIONS – CDR 11 AND CDR 12 CAPACITORS

Style Per MIL-C-55681	Length (L) Inches (mm)	Width (W) Inches (mm)	Thickness (T) Min Inches (mm)	Thickness (T) Max Inches (mm)	Metalization Band (M.B.) Inches (mm)
CDR11	0.055 ± 0.015 (1.40 ± 0.381)	0.055 ± 0.015 (1.40 ± 0.381)	0.020 (0.508)	0.057 (1.45)	0.010 – 0.005 + 0.010 (0.254 – 0.127 + 0.254)
CDR12	0.055 ± 0.025 (1.40 ± 0.635)	0.055 ± 0.015 (1.40 ± 0.381)	0.020 (0.508)	0.057 (1.45)	0.010 – 0.005 + 0.010 (0.254 – 0.127 + 0.254)

See capacitor diagram on Page 15.

Consult factory for current qualification status.

MILITARY SPECIFICATION PART NUMBERS

CDR13 – MIL-PRF-55681

CAPACITOR CHARACTERISTICS – SIZE 1010

Type Designation	Capacitance (pF)	Cap. Tolerance	Rated Temp. & Voltage-Temp. Limits	Rated Voltage (V dc)
CDR1-B-0R1-B - -	0.1	B	BG, BP	200, 500
CDR1-B-0R2-B - -	0.2	B	BG, BP	200, 500
CDR1-B-0R3 - - - -	0.3	B, C	BG, BP	200, 500
CDR1-B-0R4 - - - -	0.4	B, C	BG, BP	200, 500
CDR1-B-0R5 - - - -	0.5	B, C, D	BG, BP	200, 500
CDR1-B-0R6 - - - -	0.6	B, C, D	BG, BP	200, 500
CDR1-B-0R7 - - - -	0.7	B, C, D	BG, BP	200, 500
CDR1-B-0R8 - - - -	0.8	B, C, D	BG, BP	200, 500
CDR1-B-0R9 - - - -	0.9	B, C, D	BG, BP	200, 500
CDR1-B-1R0 - - - -	1	B, C, D	BG, BP	200, 500
CDR1-B-1R1 - - - -	1.1	B, C, D	BG, BP	200, 500
CDR1-B-1R2 - - - -	1.2	B, C, D	BG, BP	200, 500
CDR1-B-1R3 - - - -	1.3	B, C, D	BC, BP	200, 500
CDR1-B-1R4 - - - -	1.4	B, C, D	BG, BP	200, 500
CDR1-B-1R5 - - - -	1.5	B, C, D	BG, BP	200, 500
CDR1-B-1R6 - - - -	1.6	B, C, D	BG, BP	200, 500
CDR1-B-1R7 - - - -	1.7	B, C, D	BG, BP	200, 500
CDR1-B-1R8 - - - -	1.8	B, C, D	BG, BP	200, 500
CDR1-B-1R9 - - - -	1.9	B, C, D	BG, BP	200, 500
CDR1-B-2R0 - - - -	2	B, C, D	BG, BP	200, 500
CDR1-B-2R1 - - - -	2.1	B, C, D	BG, BP	200, 500
CDR1-B-2R2 - - - -	2.2	B, C, D	BG, BP	200, 500
CDR1-B-2R4 - - - -	2.4	B, C, D	BG, BP	200, 500
CDR1-B-2R7 - - - -	2.7	B, C, D	BG, BP	200, 500
CDR1-B-3R0 - - - -	3	B, C, D	BC, BP	200, 500
CDR1-B-3R3 - - - -	3.3	B, C, D	BG, BP	200, 500
CDR1-B-3R6 - - - -	3.6	B, C, D	BG, BP	200, 500
CDR1-B-3R9 - - - -	3.9	B, C, D	BG, BP	200, 500
CDR1-B-4R3 - - - -	4.3	8, C, D	BG, BP	200, 500
CDR1-B-4R7 - - - -	4.7	B, C, D	BG, BP	200, 500
CDR1-B-5R1 - - - -	5.1	B, C, D	BG, BP	200, 500
CDR1-B-5R6 - - - -	5.6	B, C, D	BG, BP	200, 500
CDR1-B-6R2 - - - -	6.2	B, C, D	BG, BP	200, 500
CDR1-B-6R8 - - - -	6.8	B, C, J, K, M	BC, BP	200, 500
CDR1-B-7R5 - - - -	7.5	B, C, J, K, M	BG, BP	200, 500
CDR1-B-8R2 - - - -	8.2	B, C, J, K, M	BG, BP	200, 500
CDR1-B-9R1 - - - -	9.1	B, C, J, K, M	BG, BP	200, 500
CDR1-B-100 - - - -	10	F, G, J, K, M	BG, BP	200, 500
CDR1-B-110 - - - -	11	F, G, J, K, M	BG, BP	200, 500
CDR1-B-120 - - - -	12	F, G, J, K, M	BG, BP	200, 500
CDR1-B-130 - - - -	13	F, G, J, K, M	BG, BP	200, 500
CDR1-B-150 - - - -	15	F, G, J, K, M	BG, BP	200, 500
CDR1-B-160 - - - -	16	F, G, J, K, M	BG, BP	200, 500

SPACE LEVEL 'S'

DSCC DWG 06019

Type Designation	Capacitance (pF)	Cap. Tolerance	Rated Temp. & Voltage-Temp. Limits	Rated Voltage (V dc)
CDR1-B-180 - - - -	18	F, G, J, K, M	BG, BP	200, 500
CDR1-B-200 - - - -	20	F, G, J, K, M	BG, BP	200, 500
CDR1-B-220 - - - -	22	F, G, J, K, M	BG, BP	200, 500
CDR1-B-240 - - - -	24	F, G, J, K, M	BG, BP	200, 500
CDR1-B-270 - - - -	27	F, G, J, K, M	BG, BP	200, 500
CDR1-B-300 - - - -	30	F, G, J, K, M	BG, BP	200, 500
CDR1-B-330 - - - -	33	F, G, J, K, M	BG, BP	200, 500
CDR1-B-360 - - - -	36	F, G, J, K, M	BG, BP	200, 500
CDR1-B-390 - - - -	39	F, G, J, K, M	BG, BP	200, 500
CDR1-B-430 - - - -	43	F, G, J, K, M	BG, BP	200, 500
CDR1-B-470 - - - -	47	F, G, J, K, M	BG, BP	200, 500
CDR1-B-510 - - - -	51	F, G, J, K, M	BG, BP	200, 500
CDR1-B-560 - - - -	56	F, G, J, K, M	BG, BP	200, 500
CDR1-B-620 - - - -	62	F, G, J, K, M	BG, BP	200, 500
CDR1-B-680 - - - -	68	F, G, J, K, M	BG, BP	200, 500
CDR1-B-750 - - - -	75	F, G, J, K, M	BG, BP	200, 500
CDR1-B-820 - - - -	82	F, G, J, K, M	BG, BP	200, 500
CDR1-B-910 - - - -	91	F, G, J, K, M	BG, BP	200, 500
CDR1-B-101 - - - -	100	F, G, J, K, M	BG, BP	200, 500

For Information on MIL-PRF-55681
Visit our Website at:
www.presidiocomponents.com

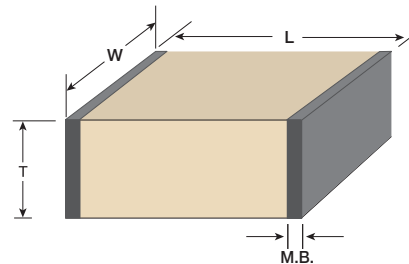

Consult Presidio for Current Qualification Status

PART NUMBER EXAMPLE (How to Order)

CDR13		BG	101	C	C	M	S
Mil Style	Voltage Temperature Limits	Capacitance	Rated Voltage Code	Cap Tolerance Code	Termination Finish		Failure Rate Level
CDR13	BG = 90 ± 20 ppm / °C BP = 0 ± 30 ppm / °C	3 Digit EIA Code	C = 200V E = 500V	B = ± .10 pF C = ± .25 pF D = ± .50 pF F = ± 1% G = ± 2% J = ± 5% K = ± 10% M = ± 20%	M = Palladium/Silver		CDR13 Only M = 1.0% P = 0.1% R = 0.01% S = 0.001%
Size 1010							

DIMENSIONS – CDR13 CAPACITORS

Style Per MIL-C-55681	Length (L) Inches (mm)	Width (W) Inches (mm)	Thickness (T) Min Inches (mm)	Thickness (T) Max Inches (mm)	Metalization Band (M.B.) Inches (mm)
CDR13	0.110 ± 0.020 (2.794 ± 0.508)	0.110 ± 0.020 (2.794 ± 0.508)	0.102 (2.591)	0.102 (2.591)	0.015 ± 0.010 (0.381 ± 0.254)

See capacitor diagram above.

PRESIDIO SCREENING LEVELS

COMMERCIAL • HR • CR

SCREENING LEVELS		Commercial*	Voltage Conditioning Per Group A of MIL-PRF-55681	DPA & Voltage Conditioning Per Group A of MIL-PRF-55681	
PREFIX:		(Blank)	HR	CR	
SCREENING LEVEL CODES:		(Blank)	(Blank)	(Blank)	
BASIC TESTING	Capacitance — All parts are tested at 25°C and 1VACRMS in accordance with Method 305 of MIL-STD-202.	100%	100%	100%	
	Dissipation Factor	100%	100%	100%	
	Dielectric Withstanding Voltage (DWV) — All parts are tested at 2.5X rated voltage up to 200V in accordance with Method 301 of MIL-STD-202.	100%	100%	100%	
	Insulation Resistance (IR at 25°C) — All parts are tested at 25°C and Rated Voltage in accordance with Method 302 of MIL-STD-202. The minimum IR required is 100,000 Megohms or 1,000 Megohm-Microfarads.	100%	100%	100%	
	Insulation Resistance (IR @ 125°C) — All parts are tested at 125°C and Rated Voltage in accordance with Method 302 of MIL-STD-202. The minimum IR required is 10,000 Megohms or 100 Megohm-Microfarads.	NO	NO	NO	
	Solderability (SnPb plated in accordance with Method 208 of MIL-STD-202). Wirebonding Test (Gold in accordance with Method 2011 of Mil-STD-883).	YES	YES	YES	
ENVIRONMENTAL TESTING AND RELIABILITY SCREENING	GROUP A	Thermal Shock (20 Cycles) — All parts are temperature cycled for 20 cycles to MIL-STD-202 Method 107, Condition A, except that max temperature is 125°C.	NO	NO	NO
		Voltage Conditioning (100%) — All parts receive a voltage conditioning at 2X rated voltage up to 200V and 125°C for a minimum of 168 hours and a maximum of 264 hours. Voltage Conditioning may be terminated at any time between 168 and 264 hour time interval when failures are less than .1% or 1 piece during the last 48 hours of the test. Method follows MIL-PRF-123. Resistors, instead of fuses are acceptable.	NO	8 Hrs. Min.	100 Hrs.
		Percent Defective Allowed (PDA) — The cumulative PDA after Voltage Conditioning is 5%. Pieces rejected as out of tolerance for capacitance or visual screening will be removed from the lot but not counted in the PDA calculation.	NO	8%	8%
		Destructive Physical Analysis (DPA) — A representative sample is pulled from each lot and examined per EIA RS469 and to verify adherence to Presidio's design criteria. Sample size is per MIL-PRF-123.	NO	NO	YES
		Voltage Temperature Limit — VTC (when applicable)	NO	NO	NO
		Visual Inspection — A 100% inspection is performed IAW MIL-PRF-123 Appendix B.	Samples	Samples	Samples
		Mechanical Inspection (Dimensions) — Level 1 AQL 1% in accordance with MIL-PRF-123.	YES	YES	YES
	GROUP B	Thermal Shock (100 Cycles) — A sample is pulled from each lot. 100 Thermal Shock cycles are performed before Life Test.	NO	NO	NO
		Life-Test — is performed for 1000 hours at 2X rated voltage up to 200V and 125°C. Sample size and method follows MIL-PRF-123.	NO	NO	NO
		Ultrasonic Examination — This screening sample will be performed on lots to assure the highest quality microstructure. 100% ultrasonic scanning is not required for each lot, and must be specified on the customer order. Separate charge applies for 100% ultrasonic scanning.	NO	NO	NO
		Humidity Steady State Low Voltage (85°C/85% humidity) — A sample of 12 pieces is pulled from each lot and tested per Method 103 of MIL-STD 202.	NO	NO	NO
		Moisture Resistance — in accordance with Method 106 of MIL-STD-202.	NO	NO	NO
	GROUP C	Terminal Strength — in accordance with Method 211 of MIL-STD-202.	NO	NO	NO
		Solderability — in accordance with Method 208 of MIL-STD-202.	NO	NO	NO
		Resistance to Soldering Heat — in accordance with Method 210 of MIL-STD-202.	NO	NO	NO
RECOMMENDED FOR SPACE FLIGHTS		NO	NO	NO	
LEAD-TIME ARO (Weeks)		3 to 13	3 to 13	3 to 13	

Call Presidio if you would like more information on our screening options.

Presidio's UP capacitors can be upscreened to SPACE LEVEL testing. Consult the factory for details. Some voltage derating may apply.

PART NUMBER EXAMPLE (How to Order)

SR	1010	UP	101	J	6	T	1	C	#M123	A
Prefix *	Size	Dielectric (See Page 3)	Capacitance	Capacitance Tolerance	Voltage	Termination	Packaging	RoHS Compliant	Screening Level (See Above)	Design-In Code (See Page 19)

PRESIDIO SCREENING LEVELS

CDR • HR#55681 • SR • SR#M123 • SR#S311 • SR#N1 • HR#N2

SCREENING LEVELS See Complete Descriptions on Page 16		MIL-PRF-55681 CDR TYPE Capacitors	Group A & B Per MIL-PRF-55681	Group A Per MIL-PRF-123 Plus Options	Group A & B Per MIL-PRF-123	Screened Per NASA DWG S311-P-829	NASA EEE-INST-002 Level 1	NASA EEE-INST-002 Level 2	
PREFIX:		CDR 11, 12 or 13	HR	SR	SR	SR	SR	HR	
SCREENING LEVEL CODES:		(See Pg. 14 & 15)	#55681	(Blank)	#M123A or #M123B	#S311	#N1	#N2	
BASIC TESTING	Capacitance	100%	100%	100%	100%	100%	100%	100%	
	Dissipation Factor	100%	100%	100%	100%	100%	100%	100%	
	Dielectric Withstanding Voltage	100%	100%	100%	100%	100%	100%	100%	
	Insulation Resistance	100%	100%	100%	100%	100%	100%	100%	
	Insulation Resistance	SAMPLE Only	SAMPLE Only	100%	100%	100%	100%	Sample	
	Solderability or Wirebonding Test	YES	YES	YES	YES	YES	YES	YES	
ENVIRONMENTAL TESTING AND RELIABILITY SCREENING	Thermal Shock (20 Cycles)	GROUP A	Periodic Testing (5 cycles)	NO	YES	YES	YES	YES	YES 5 Cycles
	Voltage Conditioning		100 Hrs.	100 Hrs.	168 H Min. with 0.1% or 1 pcs. in the last 48 Hrs.	168 H Min. with 0.1% or 1 pcs. in the last 48 Hrs.	168 H Min. with 0.1% or 1 pcs. in the last 48 Hrs.	160 Hrs.	96 Hrs.
	Percent Defective Allowed		8%	8%	5%	5%	5%	5%	10%
	Destructive Physical Analysis (DPA)		NO	NO	YES	YES	YES	YES	YES
	Voltage Temperature Limit		NO (only for qualification once a year)	Yes when applicable	Optional 12 pcs. (when applicable)	12 pcs. (when applicable)	12 pcs. (when applicable)	12 pcs. (when applicable)	6 pcs. (when applicable)
	Visual Inspection		Samples	Samples	100%	100%	100%	100%	100%
	Mechanical Inspection		YES	YES	YES	YES	YES	YES	YES
	Thermal Shock (100 Cycles)	GROUP B	Periodic Testing (5 cycles)	NO	OPTIONAL	YES	YES	NO	NO
	Life-Test		Periodic Testing (5 cycles)	2000 Hrs, 25 pcs. 1 rejects allowed	OPTIONAL	1000 Hrs. 25 or 80 or 125 pcs. 0/1/2 rejects allowed	1000 Hrs. 45 or 125 pcs. 0 rejects allowed	2000 Hrs., 22 pcs. 0 rejects allowed	1000 Hrs. 22 pcs. 1 reject allowed
	Ultrasonic Examination		NO	NO	OPTIONAL	100% (Code A) Sample (Code B)	YES Sample 100% Optional	Not required	Not required
	Humidity Steady State Low Voltage		NO (only for qualification once a year)	YES	OPTIONAL	YES	YES	YES	YES
	Moisture Resistance		NO (only for qualification once a year)	YES for Size 0805 and larger	Optional for Size 0805 and larger	Optional for Size 0805 and larger	Optional for Size 0805 and larger	YES for Size 0805 and larger	YES for Size 0805 and larger
	Terminal Strength	GROUP C	NO	NO	OPTIONAL	OPTIONAL	OPTIONAL	NO	NO
	Solderability		YES	YES	OPTIONAL	OPTIONAL	OPTIONAL	YES	YES
	Resistance to Soldering Heat		NO	NO	OPTIONAL	OPTIONAL	OPTIONAL	YES	YES
RECOMMENDED FOR SPACE FLIGHTS		YES for S-Level	YES with full Group C	YES (depending on screening options purchased)	YES	YES	YES	YES	
LEAD-TIME ARO (Weeks)		3 to 13	3 to 13	3 to 22	3 to 22	3 to 22	3 to 28	3 to 22	

Call Presidio if you would like more information on our screening options.

Presidio's UP capacitors can be upscreened to SPACE LEVEL testing. Consult the factory for details. Some voltage derating may apply.

PART NUMBER EXAMPLE (How to Order)

SR	1010	UP	101	J	6	T	1	C	#M123	A
Prefix *	Size	Dielectric (See Page 3)	Capacitance	Capacitance Tolerance	Voltage	Termination	Packaging	RoHS Compliant	Screening Level (See Above)	Design-In Code (See Page 19)

* Leave blank for Commercial parts

PRESIDIO COMPONENTS RF POWER STACKS™

PRESIDIO ADVANTAGE

Ultra Lowest ESL

Typically less than half, as a result of the vertical plate design.

Ultra Low ESR

Due to internal vertical plate design, high Q porcelain ceramic and capacitor electrode connection directly to the printed circuit board.

Integrated Heat Sink

Best heat dissipation is achieved by integrating 'heat sink' electrodes with direct connection to the base plate.

Best Vibration Performance

Robust base plate and dual top lead attachment provide superior vibration tolerance.

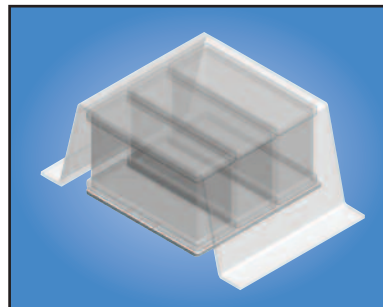
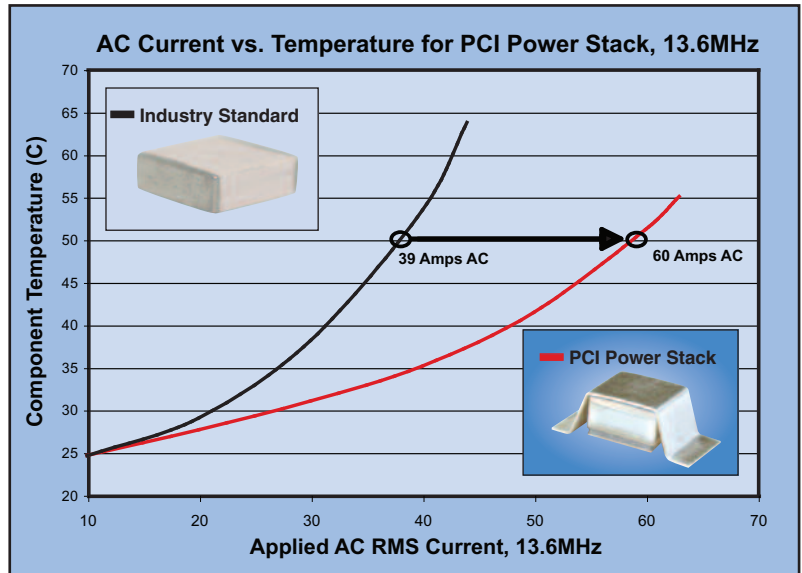

SILVER BASE PLATE

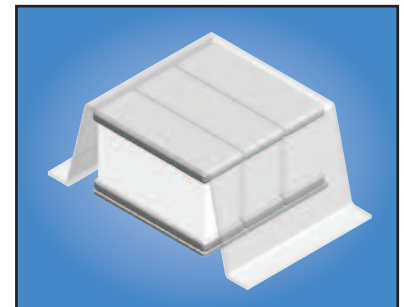

VERTICAL STACKED CAPACITORS

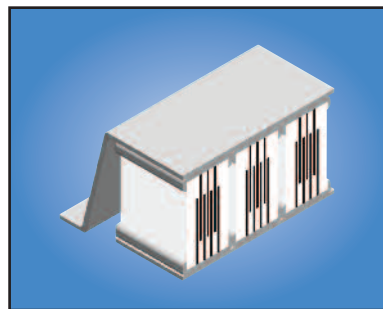

INTEGRATED "HEAT SINK" ELECTRODES

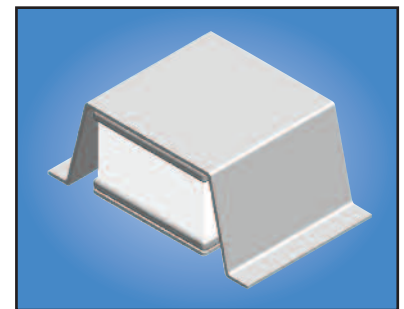

SILVER TOP LEAD

TYPICAL APPLICATIONS

- High RF Power for Commercial, Military and Space
- Non-Magnetic and Antenna Applications
- Semiconductor Manufacturing Equipment

Consult Presidio for additional information and samples.

PATENT PENDING

 PRESIDIO COMPONENTS, INC.

7169 Construction Court, San Diego, CA 92121 • Tel: 858-578-9390 • Fax: 858-578-6225
www.presidiocomponents.com • info@presidiocomponents.com

A WORD TO THE DESIGN ENGINEER

After the design work is done, outsourcing manufacturing on a global basis is a management option. At Presidio Components, we are striving for complete customer satisfaction which includes “after” service for all of our products.

We added a “Design In” locator code for quick traceability, if needed. Please select your location from the list below and add the appropriate code at the end of the part number.

If you need assistance give us a call at **(858) 578-9390** or email us at **info@presidiocomponents.com**.

UNITED STATES

OUTSIDE THE UNITED STATES

USA	Code	USA	Code	Americas	Code	Europe	Code
Alabama	G	Nebraska	P	Canada	R	Austria	3
Alaska	P	Nevada, North	B	Mexico	R	Belgium	1
Arizona	D	Nevada, South	C	Caribbean	R	Denmark	5
Arkansas	P	New Hampshire	L	Central America	R	Finland	5
California, North	B	New Jersey	J	South America	R	France	2
California, South	C	New Mexico	D			Germany	3
Colorado	E	New York, Metro	J	Pacific Rim		Ireland	6
Connecticut	L	New York, Upstate	K	Australia	S	Italy	4
Delaware	I	North Carolina	G	China	T	Luxembourg	1
District of Columbia	H	North Dakota	O	Japan	U	Netherlands	1
Florida	G	Ohio	M	Korea, South	V	Norway	5
Georgia	G	Oklahoma	P	Malaysia	W	Sweden	5
Hawaii	P	Oregon	A	Singapore	X	Switzerland	3
Idaho	A	Pennsylvania	I	Other Pacific Rim Countries	Y	United Kingdom	6
Illinois	N	Rhode Island	L			Other European Countries	7
Indiana	M	South Carolina	G			Other	
Iowa	O	South Dakota	O			India	Z
Kansas	P	Tennessee	G			Israel	8
Kentucky	M	Texas	F			Rest of World	9
Louisiana	P	Utah	E				
Maine	L	Vermont	L				
Maryland	H	Virginia	H				
Massachusetts	L	Washington	A				
Michigan	N	West Virginia	P				
Minnesota	O	Wisconsin, East	N				
Mississippi	G	Wisconsin, West	O				
Missouri	N	Wyoming	E				
Montana	A						

**PART NUMBER EXAMPLE:
0505UP101JAT1CA**
Add Design-In Code at the end
of the Presidio part number.

PRESIDIO CUSTOM PRODUCTS

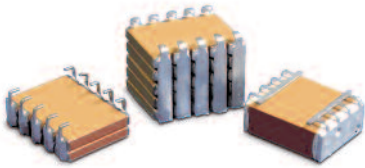

CUSTOM LEADS

PRESIDIO COMPONENTS, INC. maintains more than 100 million standard commercial and military parts in inventory. If you need a custom product, call our engineering team.



'S' LEADS

Custom products include non-standard part sizes and voltages such as high voltage, high temperature, high "Q", custom leads, cryogenic ceramics, negative and positive temperature characteristic ceramics, and piezoelectric formulations. European sizes are also available.

Backed with numerous patents and hundreds of years of combined experience, Presidio's engineering team is ready and able to create the ideal solution for any application.

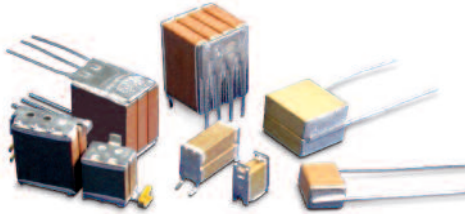

CUSTOM STACKED
CUSTOM ASSEMBLY

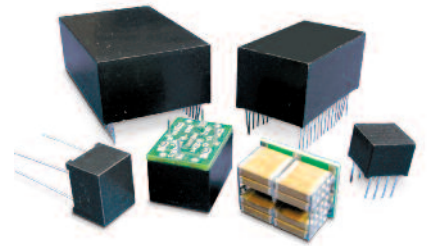

ENCAPSULATED



HIGH TEMP
DOWNHOLE OIL



POWER-STACK™
CAPACITORS



HIGH FREQUENCY
HIGH POWER

MAIN PRODUCT CATALOGS

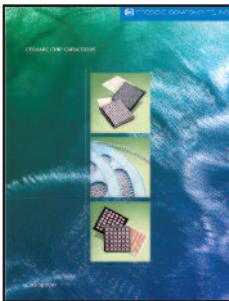

CERAMIC CHIP
CAPACITORS



HIGH RELIABILITY
EXTENDED RANGE
CHIPS FOR SPACE

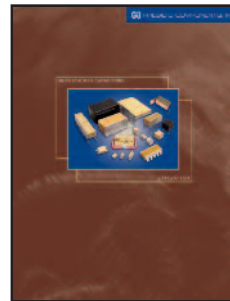

SMPS STACKED
CAPACITORS

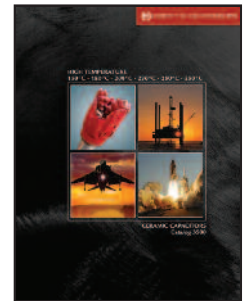

HIGH TEMPERATURE
CERAMIC
CAPACITORS



HIGH VOLTAGE &
RADIAL LEADED PRODUCTS
MIL-PRF-49467 CAPACITORS

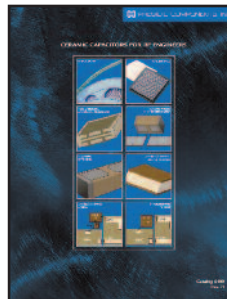

CERAMIC CAPACITORS
FOR RF, MICROWAVE &
FIBER OPTIC APPLICATIONS

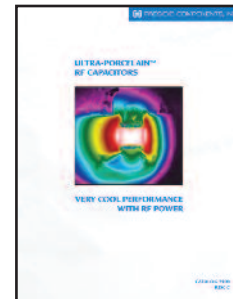

ULTRA-PORCELAIN
RF CAPACITORS